

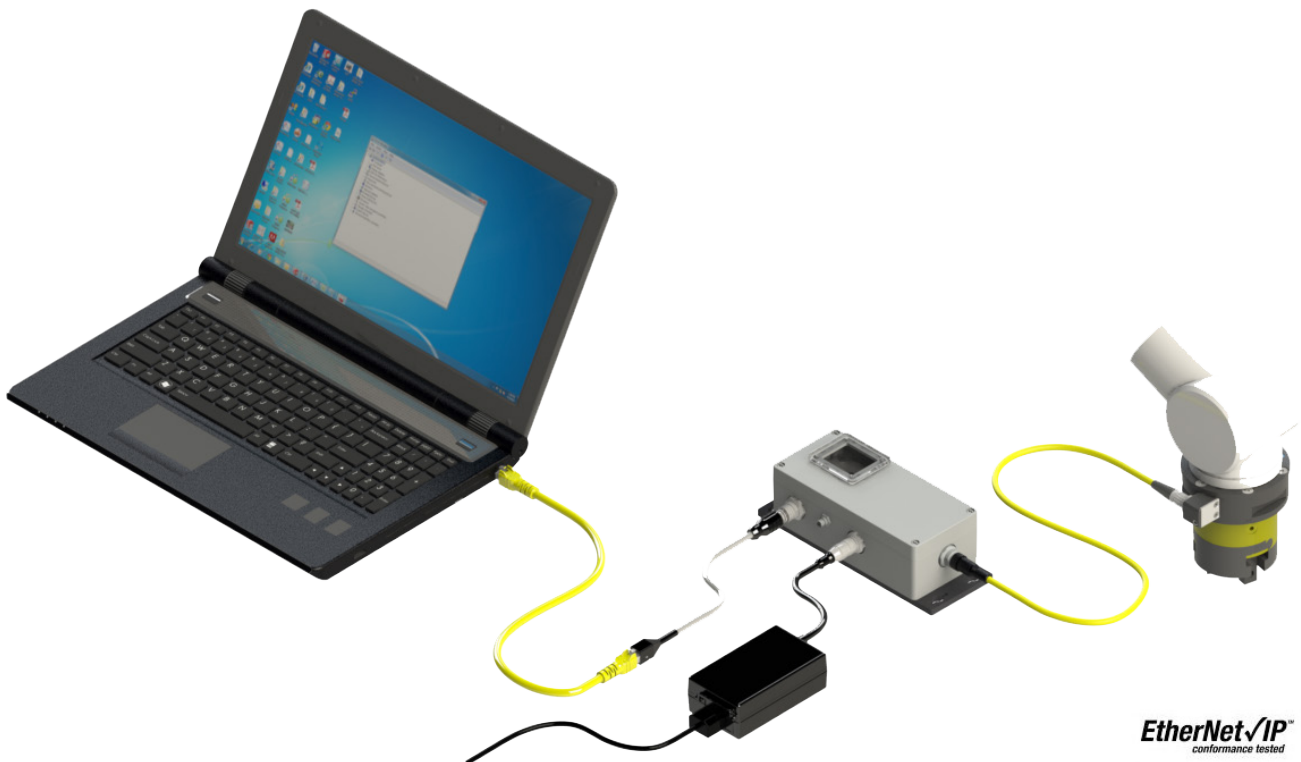

Net F/T

## Network Force/Torque Sensor System

Manual



Document #: 9620-05-NET FT

## Foreword

Information contained in this document is the property of ATI Industrial Automation, Inc. and shall not be reproduced in whole or in part without prior written approval of ATI Industrial Automation, Inc. The information herein is subject to change without notice and should not be construed as a commitment on the part of ATI Industrial Automation, Inc. This manual is periodically revised to reflect and incorporate changes made to the F/T system.

ATI Industrial Automation, Inc. assumes no responsibility for any errors or omissions in this document. Users' critical evaluation is welcome to assist in the preparation of future.

Copyright © (2023) by ATI Industrial Automation, Inc., Apex, North Carolina USA. All Rights Reserved.  
Published in the USA.

In consideration that ATI Industrial Automation, Inc (ATI) products are intended for use with robotic and/or automated machines, ATI does not recommend the use of its products for applications wherein failure or malfunction of a ATI component or system threatens life or makes injury probable. Anyone who uses or incorporates ATI components within any potentially life threatening system must obtain ATI's prior consent based upon assurance to ATI that a malfunction of ATI's component does not pose direct or indirect threat of injury or death, and (even if such consent is given) shall indemnify ATI from any claim, loss, liability, and related expenses arising from any injury or death resulting from use of ATI components.

*All trademarks belong to their respective owners.*

*Oracle and Java are registered trademarks of Oracle and/or its affiliates.*

*Windows and Excel are registered trademarks of Microsoft Corporation.*

Note

Please read the manual before calling customer service. Before calling, have the following information available:

1. Serial number (e.g., FT01234)
2. Transducer model (e.g., Nano17, Gamma, Theta, etc.)
3. Calibration (e.g., US-15-50, SI-65-6, etc.)
4. Accurate and complete Description of the question or problem
5. Computer and software information (operating system, PC type, drivers, application software, and other relevant information about the configuration)

If possible, be near the F/T system when calling.

For additional information or assistance, please refer to one of the following contacts:

Sale, Service and Information about ATI products:

**ATI Industrial Automation (a Novanta Company)**

1031 Goodworth Drive

Apex, NC 27539 USA

[www.ati-ia.com](http://www.ati-ia.com)

Tel: +1 919-772-0115

Fax: +1 919-772-8259

**Application Engineering**

E-mail: [ft.support@novanta.com](mailto:ft.support@novanta.com)

24/7 Support: +1 855 ATI-IA 00 (+1 855-284-4200)

## Table of Contents

<b>Foreword</b> .....	<b>B-2</b>
<b>Glossary</b> .....	<b>B-9</b>
<b>1. Safety</b> .....	<b>B-11</b>
1.1 Explanation of Notifications .....	B-11
1.2 General Safety Guidelines .....	B-11
1.3 Safety Precautions .....	B-11
<b>2. System Overview</b> .....	<b>B-12</b>
2.1 Multiple Calibrations .....	B-12
2.2 Multiple Configurations .....	B-12
2.3 Force and Torque Values .....	B-12
2.4 System Status Code .....	B-12
2.5 Monitor Conditions .....	B-12
2.6 Tool Transformations .....	B-12
2.7 Multiple Interfaces .....	B-12
2.8 Power Supply .....	B-12
<b>3. Getting Started</b> .....	<b>B-13</b>
3.1 Unpacking .....	B-13
3.2 System Components Description .....	B-13
3.2.1 F/T Transducer .....	B-14
3.2.2 Transducer Cable .....	B-15
3.2.3 Net Box .....	B-15
3.3 Connecting the System Components .....	B-16
3.3.1 Connecting the Transducer to the Net Box .....	B-16
3.3.2 Providing Power to the Net F/T .....	B-16
3.3.2.1 Method 1: Providing Power with PoE .....	B-16
3.3.3 Connecting to Ethernet .....	B-18
3.3.3.1 Option 1: Connect to an Ethernet Network .....	B-19
3.3.3.2 Option 2: Connect directly to a Computer's Ethernet Interface .....	B-19
3.4 IP Address Configuration for Ethernet .....	B-20
3.5 Connecting to Ethernet using a Windows Computer .....	B-21
3.6 Connecting to an Ethernet-based Fieldbus .....	B-25
3.7 Connecting to DeviceNet (using DeviceNet-Compatibility Mode) .....	B-25
3.8 Connecting the Net Box to a CAN Bus Network .....	B-25
3.9 DIP Switches and Termination Resistor .....	B-25
3.9.1 Termination Resistor .....	B-26
3.9.2 Node Address .....	B-26

3.9.3	Baud Rate .....	B-29
<b>3.10</b>	<b>Baud Rate.....</b>	<b>B-29</b>
<b>3.11</b>	<b>Power-Up Cycle .....</b>	<b>B-30</b>
<b>4.</b>	<b>Web Pages .....</b>	<b>B-32</b>
4.1	Welcome Web Page (index.htm) .....	B-32
4.2	Snapshot Web Page (rundata.htm).....	B-33
4.3	Demo Web Page (demo.htm).....	B-35
4.4	Settings Web Page (setting.htm) .....	B-36
4.5	Monitor Conditions Web Page (moncon.htm) .....	B-37
4.5.1	Condition Relay .....	B-40
4.5.1.1	Standard Net Box Condition Relay .....	B-40
4.6	Configurations Web Page (config.htm).....	B-44
4.7	Communication Settings Page (comm.htm).....	B-48
4.7.1	TCP Modbus Register Map .....	B-52
4.8	System Information Web Page (manuf.htm).....	B-53
4.9	Examples Web Page (output.htm) .....	B-54
4.10	ATI Web Site Menu Item .....	B-57
<b>5.</b>	<b>Java Demo Application .....</b>	<b>B-58</b>
5.1	Starting the Demo .....	B-58
5.2	Data Display with the Demo .....	B-59
5.3	Collecting Data with the Demo.....	B-60
5.4	The Errors Display of the Demo.....	B-62
5.5	Developing a Custom Java Application .....	B-63
<b>6.</b>	<b>Net F/T Configuration Utility.....</b>	<b>B-64</b>
6.1	Finding Net F/Ts on the Network .....	B-64
6.2	Backing Up a Configuration to a Computer.....	B-66
6.3	Restoring a Saved Configuration .....	B-66
6.4	Inspecting a Saved Configuration File .....	B-67
<b>7.</b>	<b>Common Gateway Interface (CGI) .....</b>	<b>B-68</b>
7.1	Settings CGI (setting.cgi) .....	B-69
7.2	Monitor Conditions CGI (moncon.cgi) .....	B-70
7.3	Configurations CGI (config.cgi).....	B-70
7.4	Communications CGI (comm.cgi).....	B-73
<b>8.</b>	<b>System Settings XML Pages .....</b>	<b>B-74</b>
8.1	System and Configuration Information (netftapi2.xml) .....	B-74
8.2	Calibration Information (netftcalapi.xml) .....	B-77

- 9. UDP Interface Using RDT.....B-78**
  - 9.1 RDT Protocol ..... B-78**
  - 9.2 Extended RDT Requests..... B-80**
  - 9.3 Calculating F/T Values for RDT ..... B-80**
  - 9.4 Multiple Clients..... B-80**
  - 9.5 Notes on UDP and RDT Mode ..... B-81**
  - 9.6 Example Code..... B-81**
- 10. TCP Interface .....B-81**
  - 10.1 General ..... B-81**
  - 10.2 Command Codes..... B-81**
  - 10.3 Read F/T Command..... B-81**
  - 10.4 Read F/T Response ..... B-82**
  - 10.5 Read Calibration Info Command..... B-82**
  - 10.6 Read Calibration Info Response ..... B-83**
  - 10.7 Write Tool Transform Command..... B-83**
  - 10.8 Write Monitor Condition Command..... B-84**
  - 10.9 Write Response ..... B-84**
- 11. EtherNet/IP Operation .....B-85**
  - 11.1 Overview ..... B-85**
  - 11.2 Module and Network Status LED ..... B-85**
- 12. DeviceNet-Compatibility Mode Operation.....B-86**
  - 12.1 Overview ..... B-86**
  - 12.2 MAC ID..... B-86**
  - 12.3 Baud Rate..... B-86**
  - 12.4 Module and Network Status LED ..... B-86**
  - 12.5 EDS File..... B-86**
- 13. EtherNet/IP and DeviceNet CIP Model.....B-87**
  - 13.1 Overview ..... B-87**
  - 13.2 Calculating F/T Values for CIP ..... B-89**
    - 13.2.1 EtherNet/IP.....B-89**
    - 13.2.2 DeviceNet.....B-89**
  - 13.3 Object Model..... B-90**
    - 13.3.1 Data Types .....B-90**
    - 13.3.2 EtherNet/IP.....B-90**
    - 13.3.3 Transducer Force/Torque Object (0x65—6 Instances).....B-91**

13.3.4	Transducer Force/Torque Object (0x65—6 Instances).....	B-91
13.3.5	System Status Object (0x67—1 Instance) .....	B-92
13.3.6	Configurations Object (0x71—16 Instances).....	B-92
13.3.7	Transducer Force/Torque Object (0x65—6 Instances).....	B-93
13.3.8	Monitor Conditions Settings Object (0x73—32 Instances).....	B-94
<b>14.</b>	<b>CAN Bus Operation .....</b>	<b>B-95</b>
14.1	<b>Overview .....</b>	<b>B-95</b>
14.2	<b>Protocol Description .....</b>	<b>B-95</b>
14.3	<b>Base Address and Communication Format.....</b>	<b>B-95</b>
14.4	<b>Baud Rate.....</b>	<b>B-96</b>
14.5	<b>Calculating F/T Values for CAN.....</b>	<b>B-96</b>
<b>15.</b>	<b>Fieldbus Operation.....</b>	<b>B-97</b>
15.1	<b>PROFINET Fieldbus Interface .....</b>	<b>B-97</b>
15.1.1	Enabling the PROFINET Interface .....	B-98
15.1.2	Communications CGI (comm.cgi) Options .....	B-100
15.1.3	XML Page Elements.....	B-100
15.1.4	Returning Default Settings .....	B-100
15.1.5	Replacing and Installed PROFINET Fieldbus Net Box .....	B-101
15.1.5.1	Replacing and Installing a PROFINET Fieldbus Net Box .....	B-101
15.1.5.2	Replacement with Previously Commissioned Fieldbus Net Box .....	B-101
<b>16.</b>	<b>Advanced Topics .....</b>	<b>B-102</b>
16.1	<b>Improving Ethernet Throughput .....</b>	<b>B-102</b>
16.1.1	Establish a Direct Connection between Net F/T and Host .....	B-102
16.1.2	Choose the Best Operating System for the Application .....	B-102
16.1.3	Increase Operating System Performance .....	B-102
16.1.4	Avoid Connecting the Net F/T to the Organization's Network .....	B-102
16.1.5	Use a Dedicated Ethernet Network for the Net F/T .....	B-102
16.2	<b>Reducing Noise .....</b>	<b>B-103</b>
16.2.1	Mechanical Vibration .....	B-103
16.2.2	Electrical Interference.....	B-103
16.3	<b>Detecting Failures (Diagnostics) .....</b>	<b>B-103</b>
16.3.1	Detecting Sensitivity Changes.....	B-103
16.4	<b>Scheduled Maintenance .....</b>	<b>B-103</b>
16.4.1	Periodic Inspection .....	B-103
16.5	<b>A Word about Resolution .....</b>	<b>B-104</b>
16.6	<b>Connecting to Specific Industrial Robots.....</b>	<b>B-104</b>
16.6.1	ABB Robotics .....	B-105
16.6.2	Denso Robotics .....	B-105

16.6.3	Fanuc Robotics .....	B-105
16.6.4	Kuka Robotics .....	B-106
16.6.5	Motoman Robotics .....	B-106
<b>17.</b>	<b>Troubleshooting .....</b>	<b>B-107</b>
17.1	System Status Code.....	B-107
17.2	Status Word .....	B-109
17.3	Questions and Answers.....	B-110
17.3.1	Errors with Force and Torque Readings.....	B-111
<b>18.</b>	<b>General Specifications.....</b>	<b>B-112</b>
18.1	Environmental .....	B-112
18.1.1	Storage and Operating Temperatures .....	B-112
18.2	Transducer Data Filtering .....	B-113
18.3	Electrical Specifications (Power Supply).....	B-114
18.3.1	Communications.....	B-114
18.3.1.1	Ethernet Interface .....	B-114
18.3.1.2	CAN Interface .....	B-115
18.3.2	Mating Connectors .....	B-115
18.3.3	Standard Condition Relay .....	B-115
18.3.4	Solid-State Condition Relay .....	B-115
18.3.5	NetBox Transducer Cabling .....	B-116
18.4	Net Box Weight.....	B-116



## Glossary

Term	Definitions
Accuracy	See Measurement Uncertainty.
Active Configuration	The configuration the system is currently using.
Calibration	The factory-supplied data used by Net F/T so it can report accurate transducer readings. Calibrations apply to a given loading range.
CAN	Controller Area Network (CAN) is a low level communication protocol used in some networks, including DeviceNet. The Net F/T system has a simple CAN protocol that can be used to read force and torque values.
CGI	Common Gateway Interface (CGI) is the method of using web URLs to communicate data and parameters back to a web device.
Compound Loading	Any force or torque load that is not purely in one axis.
Configuration	User-defined settings that include which force and torque units are reported, which calibration is to be used, and any tool transformation data.
Coordinate Frame	See Point of Origin.
DeviceNet™	A Fieldbus communication network used mostly by devices in industrial settings, that communicates using CAN. DeviceNet is a trademark of ODVA.
DeviceNet Compatibility Mode	A feature of the Net F/T that allows it to respond like a certified DeviceNet device.
DHCP	Dynamic Host Configuration Protocol (DHCP) is an automatic method for Ethernet equipment to obtain an IP address. The Net F/T system can obtain its IP address using DHCP on networks that support this protocol.
EtherNet/IP™	EtherNet/IP (Ethernet Industrial Protocol) is a Fieldbus communication network, used mostly by devices in industrial settings, that communicates using Ethernet. EtherNet/IP is a trademark of ControlNet International Ltd. used under license by ODVA.
Ethernet Network Switch	Ethernet network switches are electronic devices that connect multiple Ethernet cables to an Ethernet network while directing the flow of traffic.
Fieldbus	A generic term referring to any one of a number of industrial computer networking standards. Examples include: CAN, Modbus, and PROFINET.
FS	Full-Scale.
F/T	Force and Torque.
Fxy	The resultant force vector comprised of components Fx and Fy.
Hysteresis	A source of measurement caused by the residual effects of previously applied loads.
IP Address	An IP Address (Internet Protocol Address) is an electronic address assigned to an Ethernet device so that it may send and receive Ethernet data. IP addresses may be either manually selected by the user or automatically assigned by the DHCP protocol.
IPV4	IPV4 (Internet Protocol Version 4) describes IP addresses using four bytes, usually expressed in the dot-decimal notation, such as, 192.168.1.1 for example.
Java™	Java is a programming language often used for programs on web pages. The Net F/T demo is a Java application. Java is a registered trademark of Sun Microsystems, Inc.
MAC Address	MAC Addresses (Media Access Control Addresses) are the unique addresses given to every Ethernet device when it is manufactured, to be used as an electronic Ethernet serial number.
MAC ID	Media Access Code Identifier (MAC ID) is a unique number that is user assigned to each DeviceNet device on a DeviceNet network. Also called Node Address.
Maximum Single-Axis Overload	The largest amount of pure load (not compound loading) that the transducer can withstand without damage.
MAP	The Mounting Adapter Plate (MAP) is the transducer plate that attaches to the fixed surface or robot arm.
Measurement Uncertainty	The maximum expected error in measurements, as specified on the calibration certificate.

Term	Definitions
Net Box	The component that contains the power supply and network interfaces of the Net F/T system.
Node Address	See MAC ID.
ODVA™	ODVA (Open DeviceNet Vendors Association, Inc.) is an organization that defines DeviceNet, EtherNet/IP, and other industrial networks. ATI Industrial Automation is a member of ODVA. ODVA is a registered trademark of Open DeviceNet Vendors Association, Inc.
Overload	The condition where more load is applied to the transducer than it can measure. This will result in saturation.
P/N	Part Number
PoE	Power-over-Ethernet, or PoE, is a method of delivering electrical power to a PoE-compatible Ethernet device through the Ethernet cable. This simplifies installation of the Ethernet device since a separate power supply is not needed. The Net F/T system is PoE compatible.
Point of Origin	The location on the transducer from which all forces and torques are measured. Also known as the Coordinate Frame.
PROFINET	An Ethernet-based fieldbus used in factory automation.
Quantization	The process of converting a continuously variable transducer signal into discrete digital values. Usually used when describing the change from one digital value to the next increment.
RDT	Raw Data Transfer (RDT) is a fast and simple Net F/T protocol for control and data transfer via UDP.
Resolution	The smallest change in load that can be measured. This is usually much smaller than accuracy.
Saturation	The condition where the transducer has a load outside of its sensing range.
Sensor System	The assembly consisting of all components from the transducer to the Net Box.
TAP	Tool Adapter Plate (TAP) is the transducer surface that attaches to the load to be measured.
TCP	Transmission Control Protocol (TCP) is a low-level method of transmitting data over Ethernet. TCP provides a slower, more reliable delivery of data than UDP.
Monitor Conditions	A Net F/T function that performs a simple arithmetic comparison of a user-defined Condition to the loading on a transducer axis.
Tool Transformation	A method of mathematically shifting the measurement coordinate system to translate the point of origin and/or rotate its axes.
Transducer	Transducer is the component that converts the sensed load into electrical signals.
Txy	The resultant torque vector comprised of components Tx and Ty.
UDP	UDP (User Datagram Protocol) is a low-level method of transmitting data over Ethernet. While UDP is faster than TCP, unlike TCP lost UDP data is not resent.

## 1. Safety

The safety section describes general safety guidelines to be followed with this product, explanations of the notifications found in this manual, and safety precautions that apply to the product. Product specific notifications are imbedded within the sections of this manual (where they apply).

### 1.1 Explanation of Notifications

These notifications are used in all of ATI manuals and are not specific to this product. The user should heed all notifications from the robot manufacturer and/or the manufacturers of other components used in the installation.



**DANGER:** Notification of information or instructions that if not followed will result in death or serious injury. The notification provides information about the nature of the hazardous situation, the consequences of not avoiding the hazard, and the method for avoiding the situation.



**WARNING:** Notification of information or instructions that if not followed could result in death or serious injury. The notification provides information about the nature of the hazardous situation, the consequences of not avoiding the hazard, and the method for avoiding the situation.



**CAUTION:** Notification of information or instructions that if not followed could result in moderate injury or will cause damage to equipment. The notification provides information about the nature of the hazardous situation, the consequences of not avoiding the hazard, and the method for avoiding the situation.

**NOTICE:** Notification of specific information or instructions about maintaining, operating, installing, or setting up the product that if not followed could result in damage to equipment. The notification can emphasize, but is not limited to: specific grease types, best operating practices, and maintenance tips.

### 1.2 General Safety Guidelines

The customer should verify that the transducer selected is rated for maximum loads and moments expected during operation. For assistance, refer to F/T Transducer Manual (*9620-05-Transducer Section*—Installation and Operation Manual) or contact ATI Industrial Automation. Particular attention should be paid to dynamic loads caused by robot acceleration and deceleration. These forces can be many times the value of static forces in high acceleration or deceleration situations.

### 1.3 Safety Precautions



**CAUTION:** Do not remove any fasteners or disassemble transducers without a removable mounting adapter plate. These include Nano, Mini, IP-rated, and some Omega transducers. This will cause irreparable damage to the transducer and void the warranty. Leave all fasteners in place and do not disassemble the transducer.



**CAUTION:** Do not probe any openings in the transducer. This will damage the instrumentation.



**CAUTION:** Do not exert excessive force on the transducer. The transducer is a sensitive instrument and can be damaged by applying force exceeding the single-axis overload values of the transducer and cause irreparable damage. Small Nano and Mini transducers can easily be overloaded during installation. For specific transducer overload values, refer to the F/T Transducer manual (*9620-05-Transducer Section*).

## 2. System Overview

The Network Force/Torque (Net F/T) sensor system is a multi-axis force and torque sensor system that simultaneously measures forces  $F_x$ ,  $F_y$ , and  $F_z$  and torques  $T_x$ ,  $T_y$ , and  $T_z$ . The Net F/T system communicates via EtherNet/IP, CAN Bus, Ethernet, and is compatible with DeviceNet. Optional fieldbus interfaces are also available. Use the Net F/T's web pages to ease installation and monitor the sensor system (refer to [Section 4—Web Pages](#)).

The Net F/T system supports the following features:

### 2.1 Multiple Calibrations

The Net F/T can hold up to sixteen different transducer calibrations, and each can have a different sensing range. The different calibrations are created with different load scenarios during the calibration process at the factory and stored in the Net F/T.

Multiple calibrations allow for a larger calibration for coarse adjustments and smaller calibrations for fine adjustments, or to use the same transducer in two or more very different loading regimes. Contact ATI Industrial Automation for information on obtaining additional transducer calibrations.

To use a particular calibration, select that calibration in the active configuration.

### 2.2 Multiple Configurations

The Net F/T also holds up to sixteen different user configurations. Each configuration is linked to a user-selected calibration and may have its own tool transformation. Configurations are useful when the Net F/T is used in a variety of tasks. The currently active configuration is user selected on the Net F/T's *Settings* web page ([Section 4.4—Settings Web Page \(setting.htm\)](#)).

### 2.3 Force and Torque Values

The Net F/T outputs scaled numbers, or counts, that represent the loading of each force and torque axis. The number of counts per force unit and counts per torque unit is specified by the calibration. To use different force and torque units (i.e., a transducer is calibrated to use pounds and pound-inches, but the user prefers Newtons and Newton-meters), change the output units on the Net F/T *Configurations* web page ([Section 4.6—Configurations Web Page \(config.htm\)](#)).

### 2.4 System Status Code

Each Net F/T output data record contains a system status code which indicates the health of the transducer and the Net Box. For details, refer to [Section 17.1—System Status Code](#).

### 2.5 Monitor Conditions

The Net F/T is capable of monitoring the force and torque levels of each axis and setting an output code if a reading crosses a user defined-Condition. The Net F/T can hold up to sixteen Conditions, and each Condition can be enabled and disabled individually or as a group. Set-up Monitor Conditions on the Net F/T's *Monitor Conditions* web page ([Section 4.5—Monitor Conditions Web Page \(moncon.htm\)](#)).

### 2.6 Tool Transformations

The Net F/T is capable of measuring the forces and torques acting at a point other than the factory-defined point-of-origin (also known as the sensing reference frame origin). This change of reference is called a tool transformation. Specify tool transformations for each configuration on the Net F/T's *Configurations* web page ([Section 4.6—Configurations Web Page \(config.htm\)](#)).

### 2.7 Multiple Interfaces

The Net F/T system communicates via EtherNet/IP, CAN bus, Ethernet, and is compatible with DeviceNet. Each of these interfaces can be enabled and disabled on the Net F/T's *Communications* web page ([Section 4.7—Communication Settings Page \(comm.htm\)](#)).

### 2.8 Power Supply

The Net F/T system accepts power through PoE (Power-over-Ethernet) or from a DC power source with an output voltage between 11V and 25V.

## 3. Getting Started

This section gives instructions for setting up the Net F/T system.

### 3.1 Unpacking

- Verify that no damage occurred during shipping. Any damage should be reported to ATI Industrial Automation.
- Check the packing list for omissions.
- Standard components of a Net F/T system are:
  - Net F/T Transducer
  - Transducer cable (which may be integral to the transducer)
  - Net Box
  - ATI Industrial Automation software, calibration documents, and manuals (including this manual). This information is on the ATI website (<https://www.ati-ia.com/Products/ft/sensors.aspx>) or sent as an e-mail upon purchase of the system.
- Optional components:
  - Power supply that plugs into a 100–240 VAC (50–60 Hz) power outlet and provides power to the Net Box through the power (Pwr)/CAN connector
  - Ethernet switch supporting Power-over-Ethernet: provides network connection and supplies power over the Ethernet connector
  - RJ45 to M12 Ethernet cable adapter
  - Mini to Micro (M12) DeviceNet adapter (for the Pwr/CAN connector)
  - DeviceNet cabling (for the Pwr/CAN connector)
  - Ethernet cabling
  - Robot-grade transducer cables of different lengths

### 3.2 System Components Description

The Net F/T sensor system is a multi-axis force and torque sensor system that simultaneously measures forces  $F_x$ ,  $F_y$ ,  $F_z$ , and torques  $T_x$ ,  $T_y$ , and  $T_z$ . The Net Box also responds to DeviceNet commands sent over the CAN Bus connection.

The main components of the Net F/T system are displayed in [Figure 3.1](#).

The **Net F/T Transducer** converts the force and torque loads into electrical signals and transmits them over the transducer cable. With the exception of very tiny transducers, like the Nano and Mini series, the signals are digital. Since the Nano and Mini series transducers are too small for on-board electronics, they transmit analog signals.

The **Transducer Cable** is detachable and replaceable on transducers that use digital transmission. On other transducers, like the tiny Nano and Mini series, the transducer cable is an integral part of transducer and cannot be detached.

The **Net Box** is an IP65-rated aluminum housing that contains the power supplies and network interfaces. A digital-input version of the Net Box (NETB) is used with digital transducers while an analog-input version of the Net Box (NETBA) is used with analog transducers. For customer drawings, refer to the ATI F/T webpage: [https://www.ati-ia.com/products/ft/ft\\_literature.aspx](https://www.ati-ia.com/products/ft/ft_literature.aspx).

**Figure 3.1—Net F/T System Components**

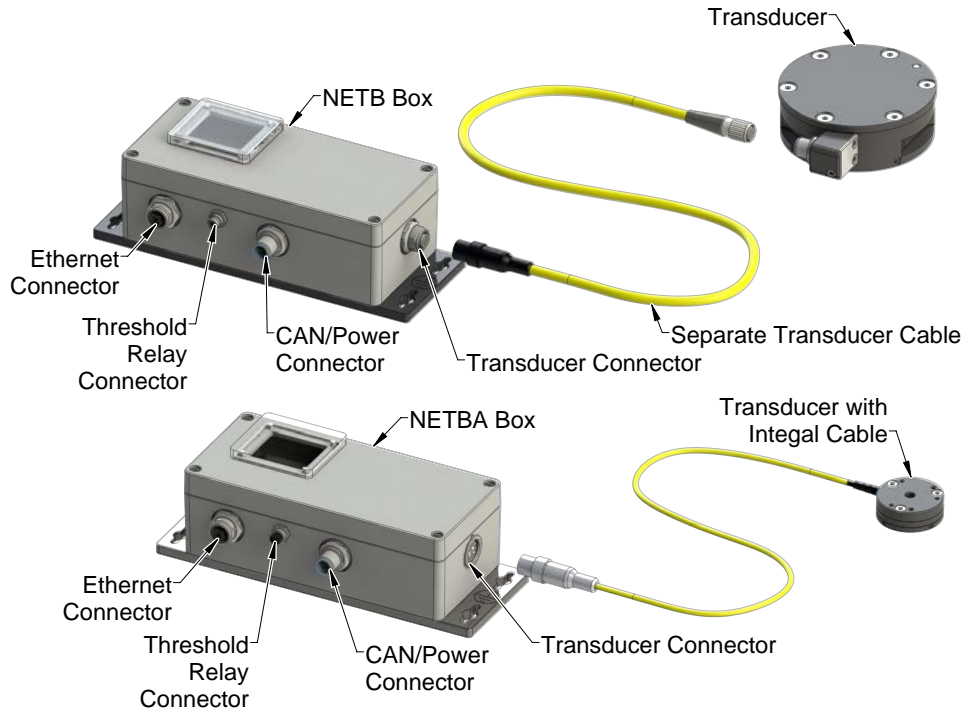

### 3.2.1 F/T Transducer

The transducer is a compact, rugged, monolithic structure that senses forces and torques.

The F/T transducer is commonly used as a wrist transducer mounted between a robot and a robot end-effector. A sample transducer is shown in [Figure 3.2](#).

For further information, refer to F/T Transducer Manual ([9620-05-Transducer Section](#)).

**Figure 3.2—Sample Transducer (Omega160)**

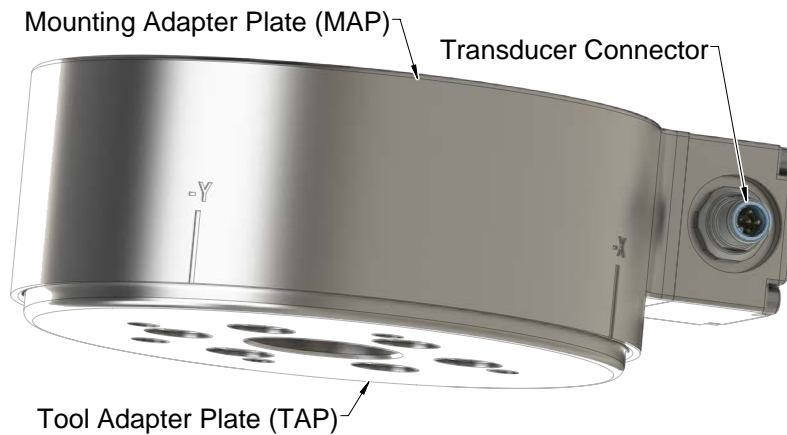

**NOTICE:** The transducer is designed to withstand extremely high overloading because of its construction using strong materials and quality silicon strain gages.



### 3.2.2 Transducer Cable

The transducer cable delivers power from the Net Box to the transducer and transmits the transducer's strain gage data back to the Net Box.

Transducers with on-board electronics (ATI Industrial Automation Part Number prefix 9105-NET) are connected to the Net Box (ATI Industrial Automation Part Number prefix 9105-NETB) via industry standard M12 Micro DeviceNet cabling. Any DeviceNet-compatible cable with correct gender M12 Micro connectors can be used, but non-IP rated transducers are not compatible with right-angled connectors. ATI Industrial Automation supplies a robotic grade high-flex transducer cable with each Net F/T system. Many other DeviceNet cable choices are available to address different requirements. In case of special requirements, contact ATI Industrial Automation or an industrial cable manufacturer (see [www.turck.com](http://www.turck.com), [www.woodhead.com](http://www.woodhead.com), and others) for available products.



**WARNING:** Transducers are not compatible with DeviceNet. Do not attempt to directly connect a transducer to a DeviceNet network. Transducers must be connected to a Net Box.

ATI's 9105-C-MTS-MS cables can connect to each other to make a multi-section cable.

**NOTICE:** If a transducer is accidentally connected to a DeviceNet network, neither the transducer nor the network will be physically harmed. Communication errors may occur on the DeviceNet network while the transducer is connected.

Transducers that do not have on-board electronics (ATI Industrial Automation Part Number prefix 9105-TW) usually have integrated cabling. Those transducers that require cabling must use an ATI Industrial Automation cable specifically made for these transducers. Transducers without the on-board electronics connect to Net Box version 9105-NETBA.

The transducer can be used in a variety of applications that affect how best to route the cable and the proper cable bending radius. Some applications allow the transducer and the cable to remain in a static condition, and other applications require the transducer to be in a dynamic condition that subjects the cable to repetitive motion. Do not let the transducer cable connectors move as a result of this repetitive motion; properly restrain the cable close the transducer connection. For proper cable routing and bending radius instructions, refer to the [9620-05 Transducer](#) manual.



**CAUTION:** Do not subject the transducer cable connector to the repetitive motion of the robot or other device. Subjecting the connector to the repetitive motion will cause damage to the connector. Restrain the cable close to the connector to keep the repetitive motion of the robot from affecting the cable connector.

### 3.2.3 Net Box

The primary function of the Net Box is to process and communicate the transducer's force and torque readings to the user's equipment. Communication can be done through Ethernet, EtherNet/IP, and CAN Bus. The Net Box also responds to DeviceNet commands sent over the CAN Bus connection.

The Net Box should be mounted in an area that it is not exposed to temperatures outside of its working range (see [Section 18.1—Environmental](#)). It is designed to be used indoors in a non-dynamic, non-vibratory environment and may be mounted in any orientation. It is designed to meet IP65 ingress protection.

The Net Box should be grounded through at least one of the four mounting tabs.

The Net Box receives power through either a standard Power-over-Ethernet (PoE) switch or the Pwr/CAN connector.

For customer drawings, refer to the ATI F/T webpage: [https://www.ati-ia.com/products/ft/ft\\_literature.aspx](https://www.ati-ia.com/products/ft/ft_literature.aspx).

### 3.3 Connecting the System Components

#### 3.3.1 Connecting the Transducer to the Net Box

The Net F/T system normally ships with an off-the-shelf standard M12 DeviceNet cable to connect the transducer to the Net Box.

Plug the female M12 connector of this cable into the male M12 socket of the transducer. Then tighten its sleeve clockwise to lock the connector. For recommended connector torque values, refer to [Section 18.3.2—Mating Connectors](#).

**Figure 3.3—Connecting Transducer Cable to Transducer and Net Box**

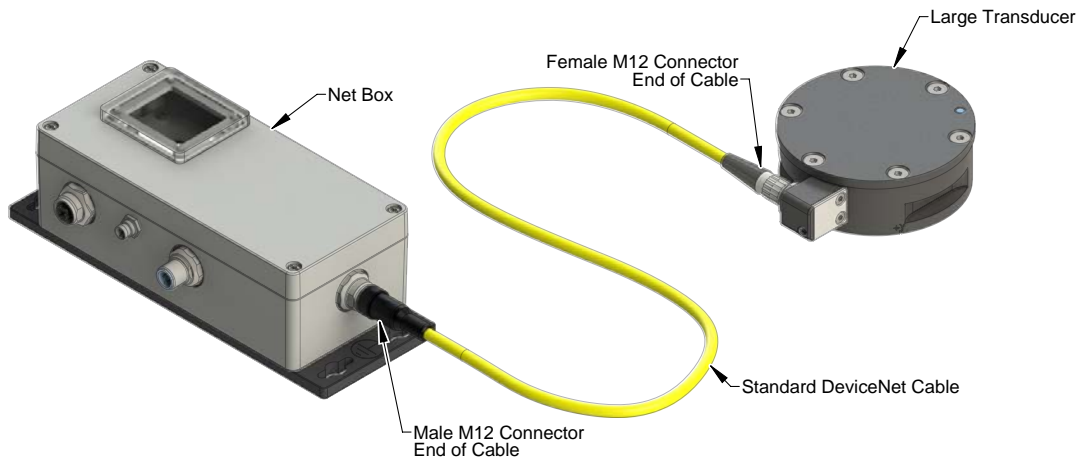

Plug the male M12 connector into the female M12 socket marked Transducer. Then turn its sleeve in a clockwise direction until tightened to lock it to the socket. See [Section 18.3.2—Mating Connectors](#) for recommended connector torque levels.

To avoid disturbed transducer signals, especially in a noisy environment and when using long transducer cables, it is highly recommended to provide a low impedance ground connection for the transducer body.

#### 3.3.2 Providing Power to the Net F/T

Two methods provide power to a standard Net F/T. Net F/Ts with an optional fieldbus interface do not support PoE and must use an external power source (Method 2).

##### 3.3.2.1 Method 1: Providing Power with PoE

**NOTICE:** PoE is not supported by Net F/Ts that have an optional fieldbus.

The Net F/T's PoE input is compatible with IEEE 802.3af PoE specification and uses Mode A to receive power. Mode B requires eight Ethernet conductors and is not supported.



The Net F/T system optionally ships with a PoE Ethernet switch. ATI Industrial Automation P/N 9105-POESWITCH-1 (see [Figure 3.4](#)) which provides PoE on four ports with RJ45 receptacles. Any PoE enabled device can get its power supply and communication signals from one of these ports. Any non-PoE device connected to these ports will receive an Ethernet connection without the power delivery. The Net F/T system accepts PoE, and thus only needs one cable connection to function on an Ethernet network.

- Connect the PoE switch to its external AC power supply.
- Connect the AC power supply to the AC mains. The PWR LED should turn on and glow green.
- Connect the PoE switch to an Ethernet network and connect the Net Box via RJ45 cable to one of the PoE ports. See [Section 3.3.3—Connecting to Ethernet](#) for information on making an Ethernet connection.

**Figure 3.4—Connecting to the Ethernet**

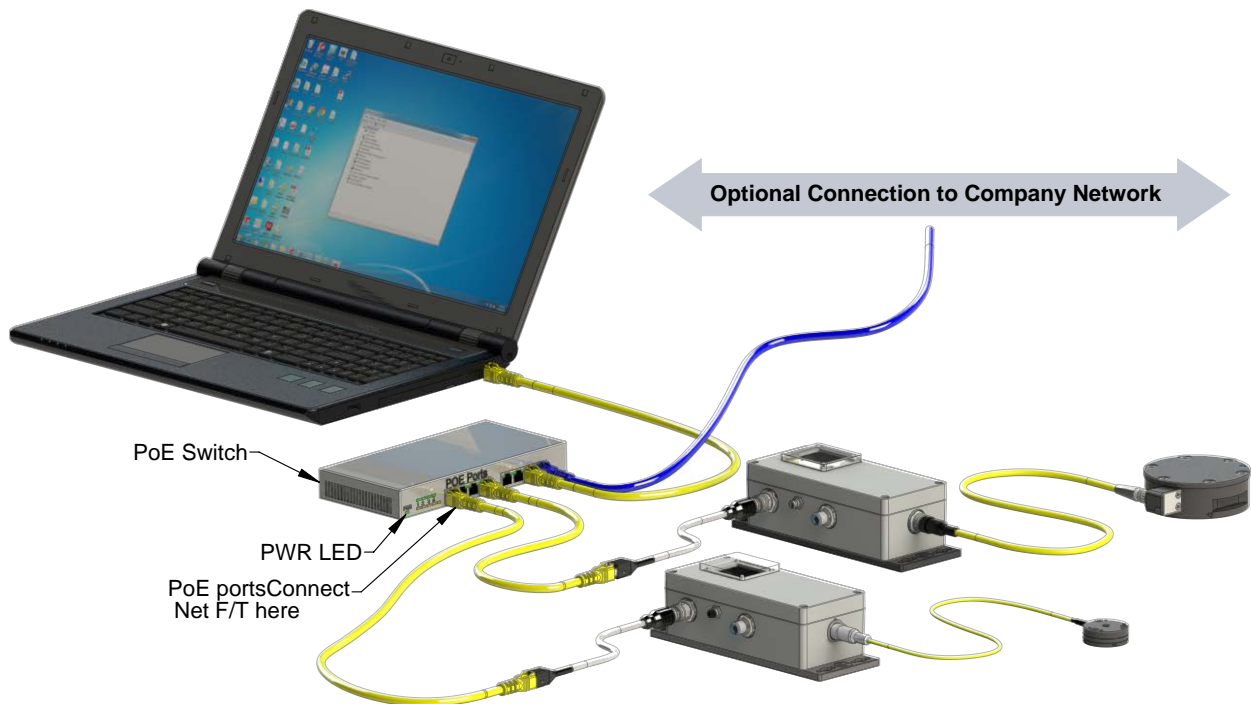

Once the Net Box is connected to the PoE switch, it should start up, first with red and green blinking LEDs. After approximately 20 seconds, all LEDs should be green.

**NOTICE:** If power is not provided to the Pwr/CAN connection then CAN bus baud rate, CAN bus base address, and DeviceNet MAC IDs are not correctly reported and communications over the Pwr/CAN connector are not available.

### 3.3.2.2 Method 2: Providing Power to Pwr/CAN Input

Instead of supplying power with the PoE option, use the 11 V to 25 V DC power input of the M12 Pwr/CAN connector. For recommended connector torque values, refer to [Section 18.3.2—Mating Connectors](#).

**Figure 3.5—Pwr/CAN Micro Connector (view from male pin side)**

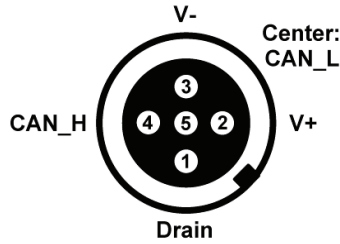

The Net F/T may ship with an optional power adapter (ATI P/N 9105-NETPS) that directly connects to the Pwr/CAN connector and delivers sufficient power for the Net F/T system.

Instead of using this power adapter, connect to a user-supplied DC power source as long as there is sufficient voltage and current (see [Section 18.3.2—Mating Connectors](#) for details) to the V+, V- inputs of the Pwr/CAN connector. ATI Industrial Automation offers an optional M12 female connector with screw terminals (ATI P/N 1510-2312000-05) for field wiring to connect to a power source. Note that although the connector provides access to CAN\_H, CAN\_L, and Drain connections, if they are not being used for CAN communications, leave these pins unconnected.

**Figure 3.6—DC Power Source Connection (Using Pwr/CAN Connector)**

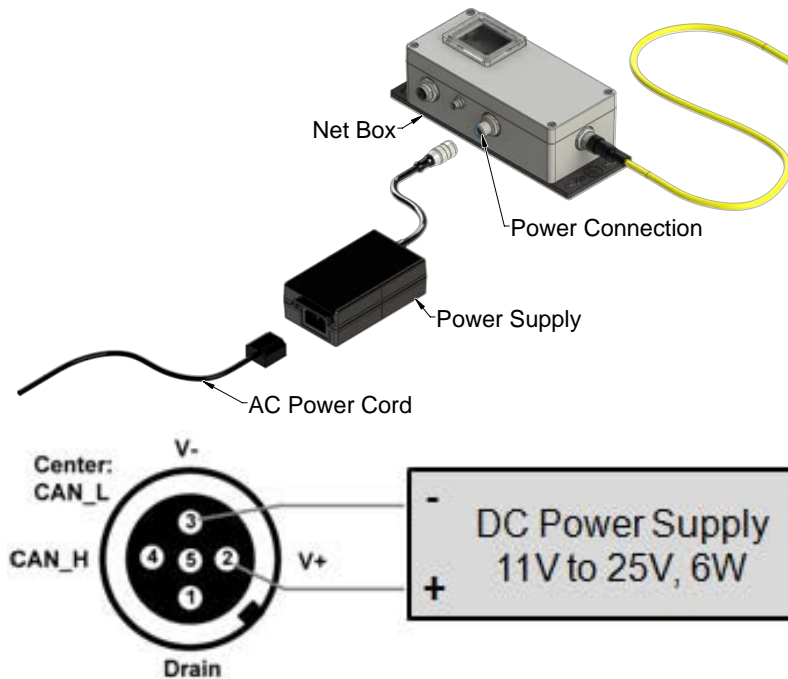

### 3.3.3 Connecting to Ethernet

This section describes how to physically connect to Ethernet. For information on configuring Net F/T's Ethernet settings, refer to [Section 3.4—IP Address Configuration for Ethernet](#), and for information on configuring a Windows XP or Windows Vista computer, refer to [Section 3.5—Connecting to Ethernet using a Windows Computer](#).

An industrial M12-4 Type-D Connector is provided for Ethernet connection. For recommended connector torque values, refer to [Section 18.3.2—Mating Connectors](#). The Net F/T system optionally ships with an off-the-shelf M12 Industrial Ethernet cable and/or an M12 to RJ45 adapter. The adapter allows the use of standard office-grade Ethernet cables with RJ45 connectors.

**Figure 3.7—Ethernet M12-4, Type-D Connector (view from female pin side)**

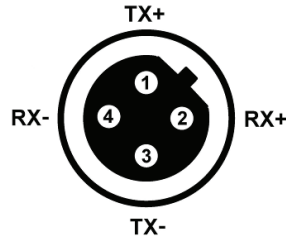

The Net Box can connect to Ethernet.

**NOTICE:** To achieve the best Ethernet performance (and to reduce the likelihood of losing data), connect the Net Box directly to the host computer, as described in Option 2.

### 3.3.3.1 Option 1: Connect to an Ethernet Network

Use the M12 to RJ45 adapter to connect a standard RJ45 Ethernet cable to the Net Box. Be certain to tighten the sleeve fully clockwise to lock the connector.

Plug the other end of the Ethernet cable into the port of an Ethernet switch. For a proposed setup, refer to [Figure 3.8](#).

**Figure 3.8—Connecting to Ethernet**

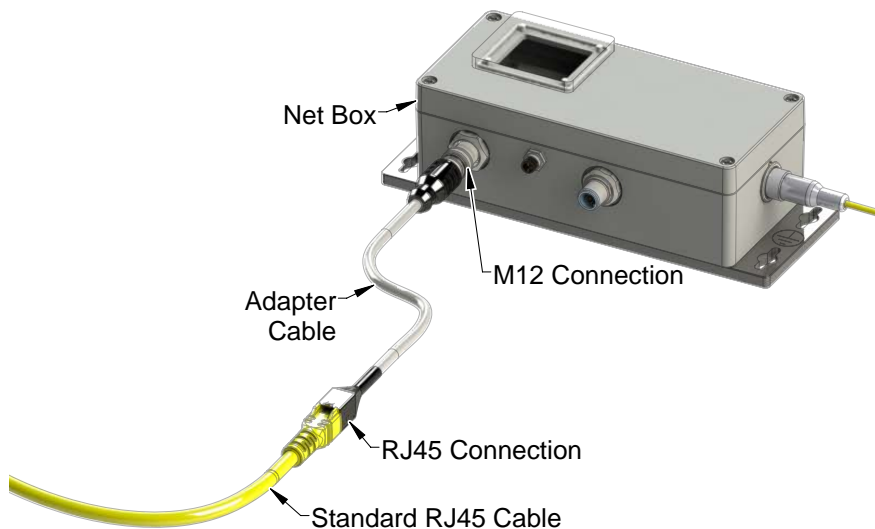

### 3.3.3.2 Option 2: Connect directly to a Computer's Ethernet Interface

The Net F/T system is connected directly to a computer's Ethernet port via a cable and is not connected to an Ethernet switch. Use the M12 to RJ45 adapter to connect a standard RJ45 Ethernet cable to the Net box. The most basic configuration would be a point-to-point connection between a computer's Ethernet interface and the Net F/T's Ethernet interface (see [Figure 3.9](#)). In this case, power has to be provided via the Pwr/CAN connector (see [Section 3.3.2.2—Method 2: Providing Power to Pwr/CAN Input](#) for details). This configuration has the lowest latency and lowest chance of lost data packages and provides the best high-speed connection.

If necessary, the computer may be connected to an Ethernet network via a second Ethernet port on the computer. Note that most computers do not have a second Ethernet port and one may need to be installed. Doing so is outside the scope of this document. Users should contact their IT department for assistance.

**Figure 3.9—Point-to-Point Ethernet Connection**

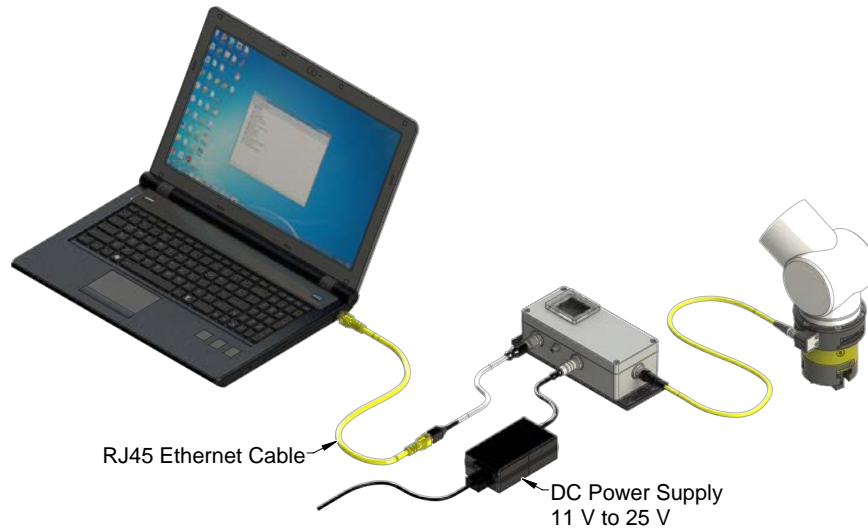

### 3.4 IP Address Configuration for Ethernet

The Net F/T system's IP address settings are only loaded upon power up, consequently the Net F/T must be power cycled for new IP address setting changes to be used. There are three methods the Net F/T system's IP address can be configured.

- Method 1:** Set IP address 192.168.1.1 by setting DIP switch 9 to the ON position.
- Method 2:** Set IP address to a static value stored on the Net F/T's *Communication Settings* web page (DIP switch 9 must be in the OFF position). This method is described in [Section 3.5—Connecting to Ethernet using a Windows Computer](#).
- Method 3:** Let a DHCP server take care of the IP address assignment (DIP switch 9 must be in the OFF position). This option can be enabled in the Net F/T's web pages (see [Section 3.5—Connecting to Ethernet using a Windows Computer](#) for details). To use this method, a DHCP server must be present in the network. This is usually the case in company networks.

The Net F/T is shipped with DHCP enabled and the static IP address set to 192.168.1.1. If the network does not support DHCP, the static IP address is automatically used. If a LAN connection is absent during power up, DHCP is not be used.

### 3.5 Connecting to Ethernet using a Windows Computer

Most of the Ethernet configuration is completed through the ATI Net F/T's web pages. To initially access the web pages, set-up the Net F/T to work on the network by assigning it an IP address and telling it basic information about the network.

For purposes of this initial connection, a computer is connected directly to the Net F/T and disconnected from the LAN. Temporarily provide a computer with a fixed IP address of 192.168.1.100. It is important that the Ethernet cable to the Net F/T is disconnected from the computer during this step.

**NOTICE:** If a computer has multiple connections to Ethernet, such as a LAN connection and a wireless connection, be sure to select the LAN that will be connected to the Net F/T.

1. Unplug the Ethernet cable from the LAN port on the computer.
2. Open the computer's Internet Protocol (TCP/IP) Properties window. Refer to the appropriate set of instructions depending on the computer operating system:
  - Windows 10:
    - a. From the **Start** menu, select **Control Panel**.
    - b. Click on the **Network and Internet** icon.
    - c. Click on the **Network and Sharing Center** icon.
    - d. Click on the **Change adapter settings** link on the left side of the window.
  - A new window opens that displays the available network adapters.
    - e. Right click the network adapter to which the sensor is connected.
    - f. From the dropdown menu, select **Properties**.

**Figure 3.10—Windows 10 Networking Information**

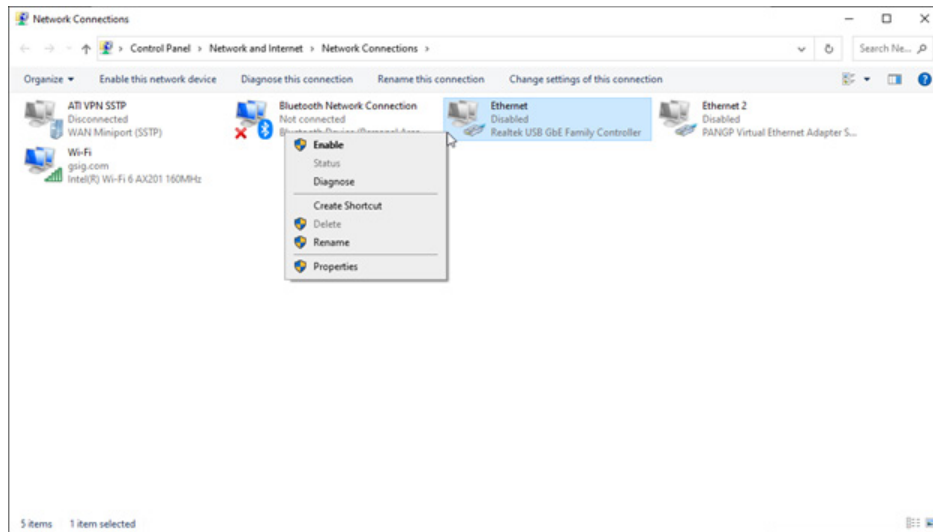

- g. In the Ethernet Properties' Networking tab, select **Internet Protocol Version 4 (TCP/IPv4)** from the list of items (refer to [Figure 3.11](#)).
- h. Click the **Properties** button.

- Windows Vista and Windows 7:
  - a. From the **Start** menu, select **Control Panel**.
  - b. For Vista, click on **Control Panel Home**.
  - c. Click on the **Network and Internet** icon.
  - d. Click on the **Network and Sharing Center** icon.
  - e. For Vista, click on the **Manage Network Connections** task link. For Windows 7, click on the **Local Area Connection** link.
  - f. For Vista, right-click on **Local Area Connection** and click the **Properties** button. For Windows 7, click on the **Properties** button.
  - g. Select **Internet Protocol Version 4 (TCP/IPv4)** connection item and click on the **Properties** button.

**Figure 3.11—Connection Properties**

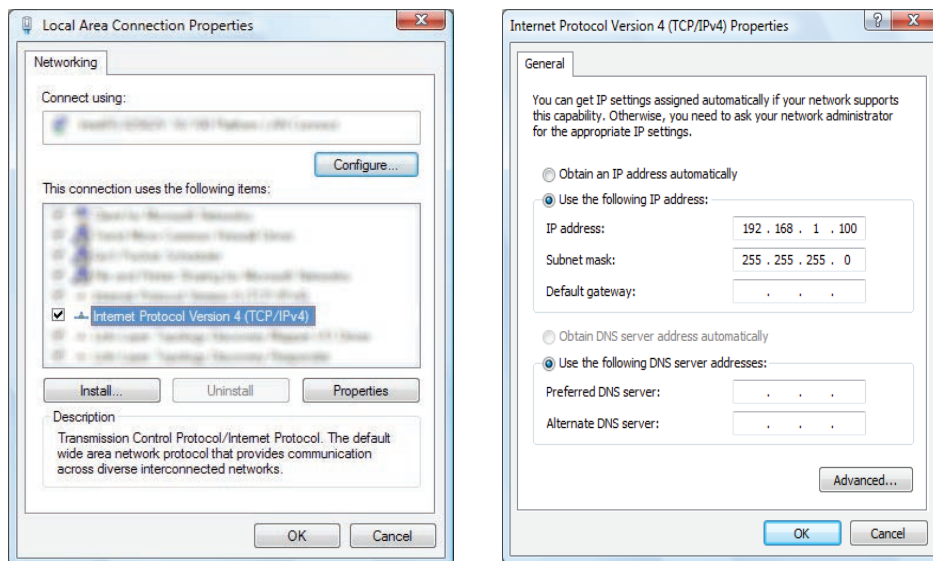



- Windows XP:
  - a. From the **Start** menu, select **Control Panel**.
  - b. Select the **Network Connections** icon from within the Control Panel. If the Control Panel says **Pick a category** at the top, first click on the **Network and Internet Connections** icon.
  - c. Click on the **Network Connections** icon.
  - d. Right-click on **Local Area Connection** and select **Properties**.
  - e. Select **Internet Protocol (TCP/IP)** connection item and click on the **Properties** button.

**Figure 3.12—Windows XP Networking Information**

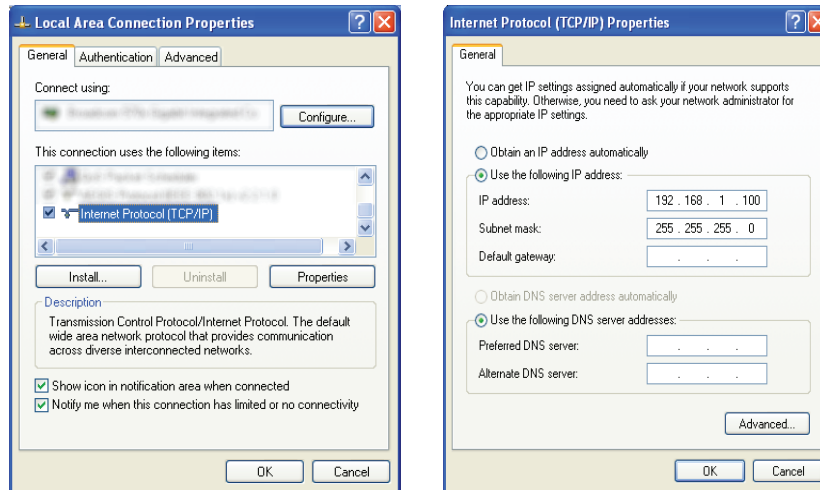

(Continued—Section 3.5: Connecting to Ethernet using a Windows Computer)

3. Record the values and settings shown in the properties window. Use these recorded values later to return the computer to its original configuration.
4. Select the **Use the following IP address** button.
5. In the **IP address:** field, type 192.168.1.100.
6. In the **Subnet mask:** field, type 255.255.255.0.
7. Click on the **OK** button.
8. Click on the **Local Area Connection Properties** window's **Close** button.
9. Use an Ethernet cable to connect the Net F/T system to the computer's LAN connection. Wait for the computer to recognize the connection.
10. Type the address *192.168.1.1* in the web browser to view the *ATI Net F/T's Welcome* page.

**Figure 3.13—The Net F/T's Welcome Page**

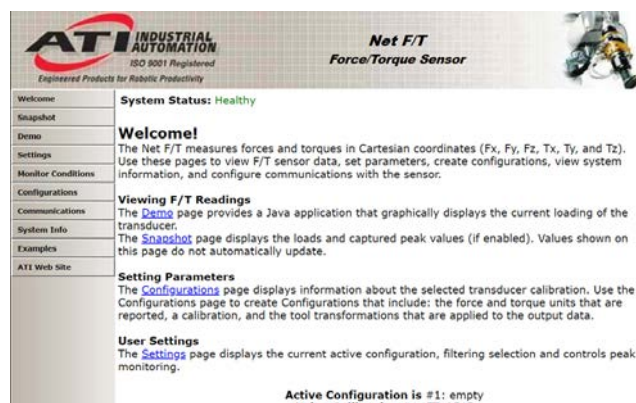

11. On the left side of the page are menu buttons that link to various Net F/T web pages. Click on the **Communications** button.

Figure 3.14—The Net F/T’s Communications Page (with Fieldbus Option)

The screenshot displays the 'Communications' configuration page for the Net F/T. The page is divided into several sections: Ethernet Network Settings, Fieldbus Module Settings, CAN Network Settings, Raw Data Transfer (RDT) Settings, and Modbus TCP Settings. Each section contains various configuration options, including IP address mode, static IP address, subnet mask, default gateway, protocol settings, and module-specific parameters. The 'System Status' is shown as 'Healthy'.

ATI INDUSTRIAL AUTOMATION ISO 9001 Registered Engineered Products for Robotic Productivity	Net F/T Force/Torque Sensor
Welcome	System Status: <b>Healthy</b>
Snapshot	<b>Communications</b>
Demo	These settings control how the Net F/T communicates with external equipment. Most settings require the Net F/T to be powered off and then back on before they take effect.
Settings	To save the values, you must click <i>Apply</i> .
Monitor Conditions	<b>Ethernet Network Settings</b>
Configurations	DIP switch 9 must be <i>off</i> to enable IP Address Mode. If DIP switch 9 is <i>on</i> , then the IP address is set to 192.168.1.1 regardless of the <i>IP Address Mode</i> settings below. A LAN connection must be present at power up for DHCP to function. If DHCP is enabled and no DHCP server is found, then the static IP address will be used.
Communications	IP Address Mode: <input checked="" type="radio"/> DHCP <input type="radio"/> Static IP <small>see above note regarding DIP switch 9</small>
System Info	Static IP Address: <input type="text" value="192.168.1.1"/>
Examples	Static IP Subnet Mask: <input type="text" value="255.255.255.0"/>
ATI Web Site	Static IP Default Gateway: <input type="text" value="0.0.0.0"/>
	EtherNet/IP Protocol: <input type="radio"/> Enabled <input checked="" type="radio"/> Disabled
	Ethernet/IP O2T Data: <input type="radio"/> Enabled <input checked="" type="radio"/> Disabled
	Ethernet/IP Data Format: <input checked="" type="radio"/> 32-bit Signed Data <input type="radio"/> 16-bit Unsigned Data
	Ethernet MAC Address: <input type="text" value="00:16:BD:00:21:22"/>
	<b>Fieldbus Module Settings</b>
	<small>Starting in units shipped with firmware version 2.2.59, the PROFINET fieldbus module used in the Net F/T requires a newer GSDML file than the file used with previous firmware versions. Make sure you have the correct GSDML file for your unit. The GSDML file for the Net F/T is available on ATI's website. <a href="#">Click this link to get the correct GSDML file.</a></small>
	Fieldbus Module Firmware Name: <input type="text" value="PROFINET Slave"/>
	Fieldbus Module Firmware Version: <input type="text" value="1.5.16"/>
	Fieldbus Module Enabled: <input checked="" type="radio"/> Enabled <input type="radio"/> Disabled
	Fieldbus Module Output Byte Order: <input checked="" type="radio"/> Little Endian <input type="radio"/> Big Endian
	<b>CAN Network Settings</b>
	<small>If power is not provided to the Pwr/CAN connector, then CAN Bus Base Address, DeviceNet MAC ID, and Baud Rate are not correctly reported and communications over the Pwr/CAN connector are not available.</small>
	Protocol: <input checked="" type="radio"/> CAN Bus <input type="radio"/> DeviceNet
	CAN Bus Base Address: <input type="text" value="432"/> <small>set by DIP switches 1 to 6</small>
	DeviceNet MAC ID: <input type="text" value="54"/> <small>set by DIP switches 1 to 6 (inaccurate without DeviceNet connection)</small>
	Baud Rate: <input type="text" value="125"/> kHz <small>set by DIP switches 7 and 8</small>
	<b>Raw Data Transfer (RDT) Settings</b>
	<small>RDT data is routed through the local network and does not get routed through the default gateway.</small>
	RDT Interface: <input checked="" type="radio"/> Enabled <input type="radio"/> Disabled <small>demo application requires RDT to be enabled</small>
	RDT Output Rate (1 to 7000): <input type="text" value="7000"/> Hz <small>value may be rounded up; see manual for details</small>
	RDT Buffer Size (1 to 40): <input type="text" value="10"/>
	Multi-Unit Synchronization: <input type="radio"/> Enabled <input checked="" type="radio"/> Disabled
	Multi-Unit Id (1 to 9): <input type="text" value="1"/>
	<b>Modbus TCP Settings</b>
	Modbus Server: <input type="radio"/> Enabled <input checked="" type="radio"/> Disabled
	Modbus Client: <input type="radio"/> Enabled <input checked="" type="radio"/> Disabled
	Modbus Client's Tx Interval (ms): <input type="text" value="0"/>
	Modbus Client's Server IP Address: <input type="text" value="0.0.0.0"/>
	Modbus Client's Server Write Register: <input type="text" value="0"/>
	Modbus Client's Server Read Register: <input type="text" value="50"/>
	<input type="button" value="Apply"/> <input type="button" value="Cancel"/>

12. Select the IP address mode.

- a. If the user’s IT department provided settings for a static IP address, type the provided values for the IP address, subnet mask, and default gateway, then click the **Apply** button. Power-cycle the Net Box (if using PoE, unplug the Net Box from PoE switch, and then plug it back into the switch). Go to step 13.
- b. If the user’s IT department provided settings for DHCP, click the **Enabled** radio button next to DHCP, and then click the **Apply** button at the bottom. Power-cycle the Net Box (if using PoE, unplug the Net Box from the PoE switch, and then plug it back into the switch).



Next, find the IP address assigned to the Net F/T by following the instructions in [Section 6.1—Finding Net F/Ts on the Network](#).

**NOTICE:** IP addresses assigned by a DHCP server are not permanent and may change if the Net F/T is disconnected from the network for a period of time. Users should contact their IT department for more information.

13. Open up the TCP/IP properties of the local area connection again. Restore the settings to the values before the settings were reconfigured. These are the values recorded in Step 3.

14. Open up a new web browser window, type the IP address given to the Net F/T system into the browser's address bar, and press the ENTER key. The ATI Net F/T's *Welcome* web page displays again. Now it is possible to communicate with the Net F/T without reconfiguring the communication settings.

**NOTICE:** If the *Net F/T Configuration Utility* found the Net F/T, but the internet browser is unable to open the found IP address, try clearing previous device entries from the computer's ARP table. Do this by either restarting the computer or, using administrative privileges, go to the computer's **Start** menu, select **Run...**, and type "arp -d \*".

This step is necessary if another device previously occupied the same IP address that the Net F/T is now using.

For more information about NET F/T Configuration Utility, refer to [Section 6—Net F/T Configuration Utility](#).

### 3.6 Connecting to an Ethernet-based Fieldbus

Net F/Ts with an optional fieldbus module connect to the fieldbus via the Net F/T's standard Ethernet connection. Although the fieldbus uses the same Ethernet connection that the Net F/T uses for its standard communications, the fieldbus option has its own MAC address and its own IP address. The fieldbus's MAC address is shown as MAC ID 2 on the connector side of the Net Box.

To be used, the fieldbus module option must be enabled on the Net F/T's *Communications* page (refer to [Section 4.7—Communication Settings Page \(comm.htm\)](#)).

### 3.7 Connecting to DeviceNet (using DeviceNet-Compatibility Mode)

To operate the Net F/T over a DeviceNet network, enable the Net F/T system's DeviceNet compatibility mode. The DeviceNet-compatibility mode fully implements all DeviceNet commands. The DeviceNet MAC ID address and baud rate settings follow [Section 3.9—DIP Switches and Termination Resistor](#). For protocol information, refer to [Section 12—DeviceNet-Compatibility Mode Operation](#).

The Net F/T Pwr/CAN connector matches standard DeviceNet connectors and connections. The Pwr/CAN connector mates to a standard female DeviceNet M12 connector.

### 3.8 Connecting the Net Box to a CAN Bus Network

The Net F/T supports a basic CAN protocol. The CAN Bus base address and baud rate settings follow [Section 3.9—DIP Switches and Termination Resistor](#). For protocol information, refer to [Section 14—CAN Bus Operation](#).

### 3.9 DIP Switches and Termination Resistor

The configuration DIP switches and termination resistor are located inside of the Net Box where they are safely protected from outside debris and liquids. To gain connection to the switches and termination resistor, remove cover of the Net Box.

Before opening the Net Box, verify that the box is not powered and that the user and the Net Box are electrically grounded.

To remove the cover, fully loosen each of the four screws that fasten the cover to the Net Box chassis. Lift the cover straight up and off the chassis.

The internal electronics have a clear shield to protect them from debris or errant tool movements. The user can reach the DIP switches and termination resistor jumper through the access holes in the shield.

**Figure 3.15—Net Box DIP Switches, Termination Resistor and LEDs**

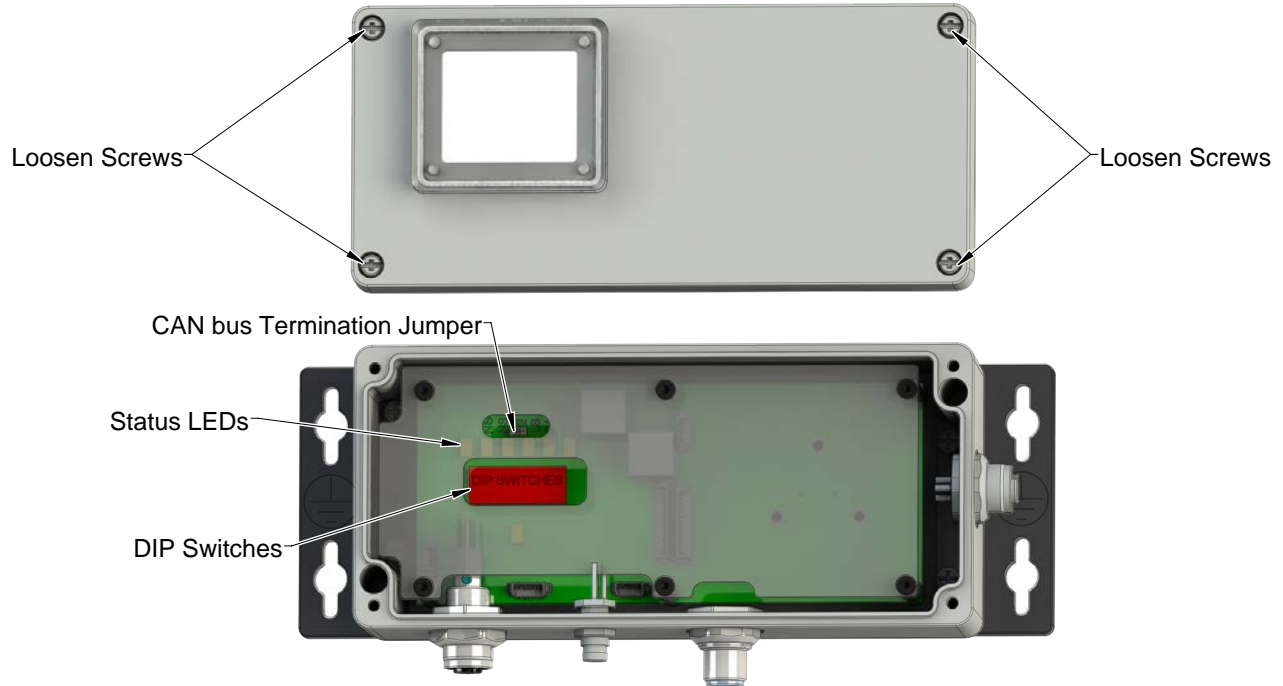

Before replacing the Net Box cover, ensure that no debris or liquids are in the chassis. Then replace the cover back on the chassis (verify that the window is above the LEDs and DIP switches) and tighten the four screws until each is snug.

### 3.9.1 Termination Resistor

By default, the Net Box ships with a CAN bus termination resistor installed. Remove the termination jumper to disable the internal termination resistor. To remove the termination resistor, use a pair of tweezers or pliers to pull the jumper off. Safely store the jumper somewhere in case it is needed to re-enable the termination resistor.

### 3.9.2 Node Address

By default, the Net Box ships with a CAN Bus base address of 432 and DeviceNet MAC ID of 54. These addresses are set by the DIP switch settings (see [Figure 3.16](#) for details).

**Figure 3.16—Net Box DIP Switches, Termination Resistor and LEDs**

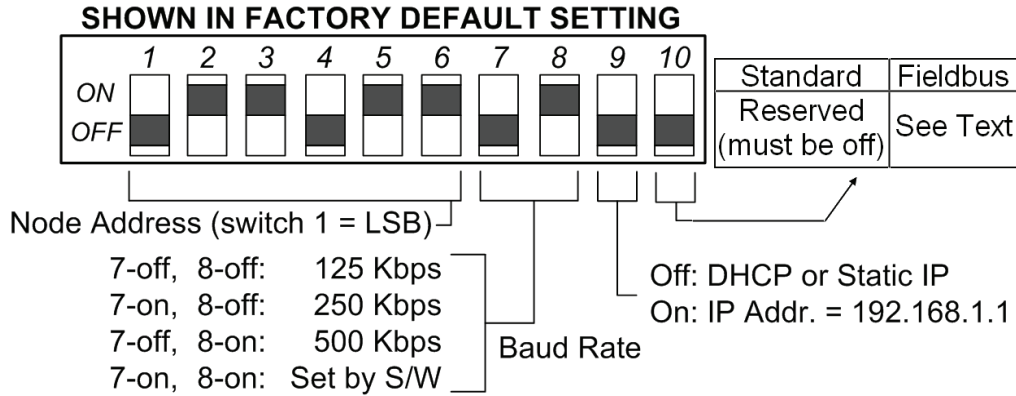

To set the desired address, use [Table 3.1](#) and [Table 3.2](#) as an aid for finding the switch settings. The numbers on the left side are the desired MAC ID, and the numbers on the right side represent the switch position settings for switches 1 through 6 to select the MAC ID. The number 1 represents a switch in the ON position and the number 0 represents a switch in the OFF position.

**NOTICE:** The Net F/T can operate in either the CAN Bus protocol or the DeviceNet-Compatibility Mode protocol, but not both protocols. Select desired protocol can be enabled on the ATI Net F/T's *Communications* web page ([Section 4.7—Communication Settings Page \(comm.htm\)](#)).

Both protocols use the same DIP switches to set their address. Be sure to use the correct address table for the desired protocol.

**Table 3.1—CAN Bus Base Address Switch Settings**

Desired Address	Switch Setting	Desired Address	Switch Setting	Desired Address	Switch Setting	Desired Address	Switch Setting
	123456		123456		123456		123456
0:	000000	128:	000010	256:	000001	384:	000011
8:	100000	136:	100010	264:	100001	392:	100011
16:	010000	144:	010010	272:	010001	400:	010011
24:	110000	152:	110010	280:	110001	408:	110011
32:	001000	160:	001010	288:	001001	416:	001011
40:	101000	168:	101010	296:	101001	424:	101011
48:	011000	176:	011010	304:	011001	432:	011011
56:	111000	184:	111010	312:	111001	440:	111011
64:	000100	192:	000110	320:	000101	448:	000111
72:	100100	200:	100110	328:	100101	456:	100111
80:	010100	208:	010110	336:	010101	464:	010111
88:	110100	216:	110110	344:	110101	472:	110111
96:	001100	224:	001110	352:	001101	480:	001111
104:	101100	232:	101110	360:	101101	488:	101111
112:	011100	240:	011110	368:	011101	496:	011111
120:	111100	248:	111110	376:	111101	504:	111111

Table 3.2—DeviceNet MAC ID Address Switch Settings							
Desired Address	Switch Setting	Desired Address	Switch Setting	Desired Address	Switch Setting	Desired Address	Switch Setting
	123456		123456		123456		123456
0:	000000	16:	000010	32:	000001	48:	000011
1:	100000	17:	100010	33:	100001	49:	100011
2:	010000	18:	010010	34:	010001	50:	010011
3:	110000	19:	110010	35:	110001	51:	110011
4:	001000	20:	001010	36:	001001	52:	001011
5:	101000	21:	101010	37:	101001	53:	101011
6:	011000	22:	011010	38:	011001	54:	011011
7:	111000	23:	111010	39:	111001	55:	111011
8:	000100	24:	000110	40:	000101	56:	000111
9:	100100	25:	100110	41:	100101	57:	100111
10:	010100	26:	010110	42:	010101	58:	010111
11:	110100	27:	110110	43:	110101	59:	110111
12:	001100	28:	001110	44:	001101	60:	001111
13:	101100	29:	101110	45:	101101	61:	101111
14:	011100	30:	011110	46:	011101	62:	011111
15:	111100	31:	111110	47:	111101	63:	111111

Setting DIP switches 1 through 8 to ON enables both DeviceNet MAC ID and baud rate to be set by software. If switches 7 or 8 are OFF, then the DeviceNet MAC ID is not set by software.

### 3.9.3 Baud Rate

By default, the Net Box ships with a baud rate of 500 kbps. This rate is set by the DIP switch settings (see [Figure 3.16](#) for details).

To set the baud rate used by DeviceNet and CAN Bus, use [Table 3.3](#) as an aid to set switches 7 and 8.

Table 3.3—Baud Rate Switch Settings	
Baud Rate	Switch Setting
	78
125 kbps:	00
250 kbps:	10
500 kbps:	01
Selected by software:	11

### 3.10 Baud Rate

The status LEDs indicate the general health and connectedness of the Net F/T. Possible LED states and meanings are listed in [Table 3.4](#) and [Table 3.5](#).

Figure 3.17—Status LEDs

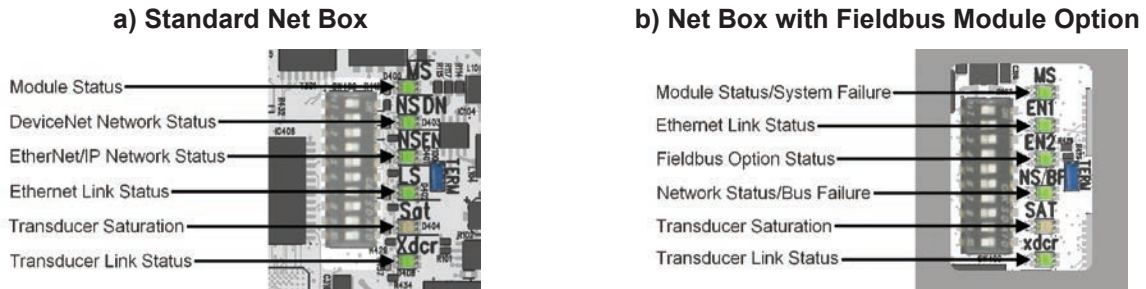

### 3.11 Power-Up Cycle

Prior to power-up, connect the transducer the Net Box and connect the Net Box to an Ethernet network. When power is applied to the Net Box, the following occurs:

- For the standard Net Box, all status LEDs blink green then red once in this order: MS, NS DN, NS EN, LS EN, Sat, and Xdcr. For the fieldbus Net Box, the LEDs blink green once then red once in this order: MS, EN1, NS/BF, Sat, and Xdcr. The EN2 LED does not blink in the sequence.
- Next the Xdcr LED glows red and the MS LED blinks red. The LS EN LED blinks green if the Net Box is connected to the Ethernet network.
- Approximately 20 seconds after power up, the MS and Xdcr LEDs should display green. This signals that the data acquisition system is now functioning.
- If the Net F/T does not power up as described, refer to [Section 17—Troubleshooting](#).

**Table 3.4—Standard Net Box Status LED Descriptions**

Status LED Function	Name on PCB	LED State	Description
Module Status	MS	Off	No power
		Green	Correct operation
		Flashing Red	Minor fault such as incorrect or inconsistent configuration
DeviceNet Compatibility-Mode Network Status	NS DN	Off	Pending duplicate MAC ID test or DeviceNet protocol not selected (or no power)
		Flashing Green	No connection to DeviceNet network
		Solid Green	DeviceNet master connected
		Flashing Red	DeviceNet I/O connection(s) timed out
EtherNet/IP Network Status	NS EN	Off	EtherNet/IP is disabled or no IP address (or no power)
		Flashing Green	IP address is assigned, but no connection to EtherNet/IP network
		Green	EtherNet/IP network connected
		Flashing Red	EtherNet/IP connection(s) timed out
Ethernet Link Status	LS EN	Off	No link (or no power).
		Green	Link
		Solid Amber	Port disabled
		Flashing Green	Port activity
		Flashing Amber	Ethernet data collision
		Red	N/A (used only during a power-up cycle)
Transducer Saturation	Sat	Off	Transducer load is appropriate (or no power)
		Red	Transducer has too much load and is saturated. This causes system load outputs to be invalid.
Sensor Link Status	Xdcr	Green	Data acquisition system functioning properly.
		Red	Data acquisition system error or power-up sequence is being executed.

**Table 3.5—Fieldbus Net Box Status LED Descriptions**

Status LED Function	Name on PCB	LED State	Description	
Module Status	MS	Off	No power	
		Green	Correct Operation	
		Flashing Red	Minor fault such as incorrect or inconsistent configuration	
Ethernet Link Status	EN1	Off	No Ethernet link (or no power)	
		Green	Ethernet link established	
		Flashing Green	Ethernet activity	
Fieldbus Option Status	EN2	Off	Fieldbus disabled (or no power)	
		Green	Fieldbus connected	
		Flashing Amber	Fieldbus activity	
		Amber		
Network Status/Bus Failure	NS/BF	The NS/BF LED displays only the status of the highest priority bus connected. The priorities are as follows, in order of highest to lowest: Fieldbus, EtherNet/IP, DeviceNet.		
		Off	<b>Bus</b>	<b>Description</b>
			PROFINET	Network connected (or no power)
			EtherNet/IP	No IP address assigned or network disabled (or no power)
			DeviceNet	Pending duplicate MAC ID test or network disabled (or no power)
		Green	<b>Bus</b>	<b>Description</b>
			PROFINET	N/A
			EtherNet/IP	Network connected
			DeviceNet	DeviceNet master connected
		Flashing Green	<b>Bus</b>	<b>Description</b>
			PROFINET	N/A
			EtherNet/IP	IP address assigned without connecting to network
		DeviceNet	No connection to network	
		Flashing Red	Connection(s) timed out	
		Red	<b>Bus</b>	<b>Description</b>
			PROFINET	Duplicate IP address found
EtherNet/IP	Duplicate IP address found or EtherNet/IP network			
DeviceNet	Network error			
Transducer Saturation	Sat	Off	Transducer load is appropriate (or no power)	
		Red	Transducer has too much load and is saturated. This causes system load outputs to be invalid	
Transducer Link Status	Xdcr	Green	Data acquisition system functioning properly	
		Red	Data acquisition system error or power-up sequence is being executed	



## 4. Web Pages

The Net F/T's web pages provide full configuration options for the Net F/T sensor system. There are several pages which can be selected by the menu bar toward the top of the web page.

The Net F/T's web pages use simple HTML and browser scripting and the pages do not require any plug-ins. If browser scripting is disabled some non-critical user interface features are not available. Because the demo program is written in Java®, verify Java is installed on the computer (refer to [Section 5—Java Demo Application](#)).

The system status is displayed near the top of all the web pages. This is the system status at the time the page was loaded. To display the current system status, reload the web page. Possible system status conditions are listed in [Section 17.1—System Status Code](#).

Figure 4.1—Menu Bar

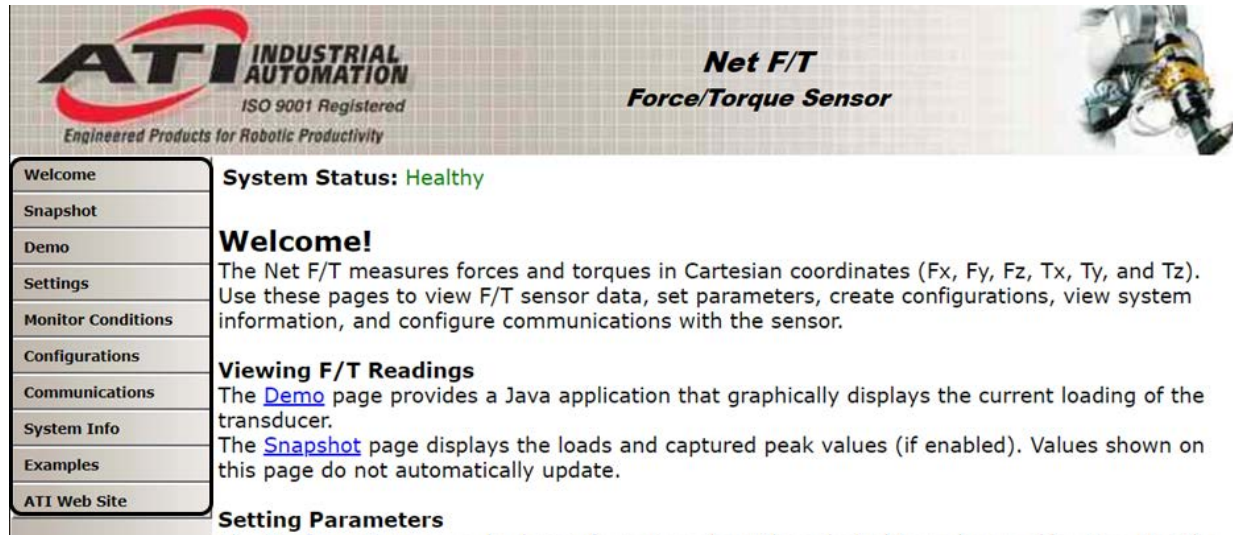

### 4.1 Welcome Web Page (index.htm)

Type the Net F/T IP address into the browser address field, and the ATI Net F/T home page (*Welcome* page) appears.

The *Welcome* page gives a quick overview of the Net F/T's main functions. The bottom of the page lists the active configuration and the calibration used by this configuration.

Figure 4.2—Welcome Web Page

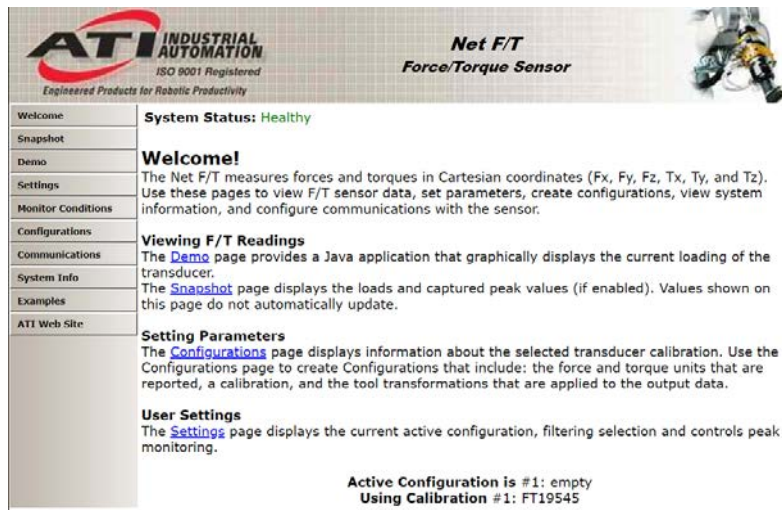



## 4.2 Snapshot Web Page (rundata.htm)

This web page allows shows current transducer loading, the maximum and minimum peaks (if peak monitoring is enabled on the *Settings* page), and the status of Monitor Conditions conditions.

The information displayed on this web page is static and does not update after the web page is loaded. To see current information, reload the web page.

Figure 4.3—Snapshot Web Page

**ATI INDUSTRIAL AUTOMATION**  
 ISO 9001 Registered  
 Engineered Products for Robotic Productivity

**Net F/T**  
 Force/Torque Sensor

Welcome | **System Status: Healthy**

Snapshot | **Loading Snapshot**

Demo | This page displays the transducer loading at the time of the loading of this web page. This page does not refresh automatically. To see the most recent transducer loading, click Refresh Page.

Settings | Values displayed in *User Units* use the *Force Units* and *Torque Units* selected in [Configurations](#).

Monitor Conditions | Values displayed in *Counts* use the *Counts per* values selected in [Configurations](#).

Configurations |

Communications |

System Info | **Transducer Loading Snapshot (User Units):**

Examples | Force/Torque Data: 

	Fx	Fy	Fz	Tx	Ty	Tz
Force/Torque Data:	-8124	-10523	-5882	-1014	422.26	1631.2
Minimum Peaks:	-8498	-10583	-6202	-1017	420.71	1612.6
Maximum Peaks:	-8117	-10519	-5397	-1011	443.08	1647.3

ATI Web Site | **Transducer Loading Snapshot (Counts):**

Force/Torque Data: 

	Fx	Fy	Fz	Tx	Ty	Tz
Force/Torque Data:	-8132050	-10528278	-6029781	-1014555	422063	1636644
Minimum Peaks:	-8498898	-10583548	-6202723	-1017719	420719	1612672
Maximum Peaks:	-8117674	-10519108	-5397260	-1011218	443089	1647344

Reset Peaks

Bias

**Strain Gage Data**

Biased Gage Data: 

	G0	G1	G2	G3	G4	G5
Biased Gage Data:	-2421	-537	-4887	-19479	1197	-7925

Unbiased Gage Data: 

	G0	G1	G2	G3	G4	G5
Unbiased Gage Data:	-2431	-553	-4899	-19494	1175	-7951

  
 Range: -32768 to +32767

**Monitor Conditions Status**

Monitor Conditions Breached: 0x00000000 statements bitmapped into lower two bytes

Monitr Conditions Output: 0x00

Monitor Conditions Latched: 0

### Transducer Loading Snapshot (User Units):

- Force/Torque Data:** Displays the force and torque data scaled in the user units selected on the *Configurations* web page. If any strain gages are saturated, these values are invalid and displayed in red with a line through them.
- Minimum Peaks:** Displays the minimum peak values captured scaled in the user units selected on the *Configurations* web page.
- Maximum Peaks:** Displays the maximum peak values captured and scaled in the user-selected units on the *Configurations* web page.

**Transducer Loading Snapshot (Counts):**

- Force/Torque Data: Displays the force and torque data scaled with the Counts per Force and Counts per Torque displayed on the *Configurations* web page. If any strain gages are saturated, these values are invalid and displayed in red with a line through them.
- Minimum Peaks: Displays the minimum peak values captured scaled with the Counts per Force and Counts per Torque displayed on the *Configurations* web page.
- Maximum Peaks: Displays the maximum peak values captured scaled with the Counts per Force and Counts per Torque displayed on the *Configurations* web page.
- Reset Peaks: This button clears the captured peaks and reloads the *Snapshot* web page.
- Bias button: Tares the force and torque values at the current readings and reloads the *Snapshot* web page. This sets the current load level as the new zero point. Undo the bias, by setting the *Software Bias Vector* to all zeros on the *Settings* web page.

**Strain Gage Data:**

- Biased Gage Data: Displays the transducer’s strain gages minus the software bias vector.
- Unbiased Gage Data: Displays the transducer’s raw strain gage information for easy troubleshooting of saturation errors. Saturated strain gage values are displayed in red.

**NOTICE:** When saturation occurs, the reported force and torque values are invalid.

**NOTICE:** Individual strain-gage values do not correspond to individual force and torque axes.

**NOTICE:** The transducer readings on this page are captured as the web page requests them. It is possible that the readings towards the bottom of the page come from later F/T data records than the readings towards the top of the page.

**Monitor Conditions Status:**

- Monitor Conditions Breached: Indicates which conditions are or have been true since the last reset latch function execution. Each bit in the lower two bytes of this hexadecimal number represents a Monitor Conditions statement. *Table 4.1* shows the bit pattern representing each Monitor Conditions statement number. The Monitor Conditions Breached value is the result of or’ing the bit patterns for all true statements together. The Monitor Conditions Breached value is cleared to zero by the reset latch function.

Table 4.1—Bit Patterns for Monitor Conditions Breached							
#:	Bit Pattern	#:	Bit Pattern	#:	Bit Pattern	#:	Bit Pattern
0:	0x00000001	4:	0x00000010	8:	0x00000100	12:	0x00001000
1:	0x00000002	5:	0x00000020	9:	0x00000200	13:	0x00002000
2:	0x00000004	6:	0x00000040	10:	0x00000400	14:	0x00004000
3:	0x00000008	7:	0x00000080	11:	0x00000800	15:	0x00008000

- Monitor Conditions Output: Displays the Monitor Conditions Output value set by bitwise or’ing the Output Codes of all true Monitor Conditions statements.
- Monitor Condition Latched: Displays one if any conditions are or have been true. The Monitor Condition Latched value is cleared to zero by the reset latch function.
- Reset Latch: This button clears any condition latching and reloads the *Snapshot* web page. If no conditions remain true, then Monitor Conditions Breached, Monitor Conditions Output, and Monitor Condition Latched are set to zero and the System Status: Condition Level Latched condition is cleared.
- Refresh Page: This button reloads the *Snapshot* web page with updated values. This button is the same as using the browser’s reload or refresh command.

### 4.3 Demo Web Page (demo.htm)

From this web page, download a Java Demo Application which is described in [Section 5—Java Demo Application](#).

Figure 4.4—Demo Web Page



**ATI INDUSTRIAL AUTOMATION**  
ISO 9001 Registered  
Engineered Products for Robotic Productivity

**Net F/T**  
**Force/Torque Sensor**

Welcome	<b>System Status:</b> Healthy
Snapshot	
Demo	<b>Demonstration Application</b>
Settings	The demonstration application graphically displays transducer readings.
Monitor Conditions	The application's features include:
Configurations	<ul style="list-style-type: none"><li>• Display of transducer loading in real time as a bar graph and a 3D cube</li><li>• Ability to save transducer readings in CSV format</li><li>• Biasing of transducer readings to zero</li><li>• Reporting of communication errors</li></ul>
Communications	
System Info	
Examples	
ATI Web Site	The demo software is available on ATI's Net F/T Software page. When starting the demo, it will ask you to enter the IP address of the sensor. The IP address of this Net F/T is: 10.1.0.134

[Download the demo software here.](#)

The application requires the Java runtime. Java can be downloaded from <http://www.java.com>. The source code for the demo can be found in the Net F/T system documentation.

## 4.4 Settings Web Page (setting.htm)

From this web page, choose the active configuration and specify settings that are effective across all configurations, such as filtering, peak monitoring, and the bias (offset) vector. Click the **Apply** button to implement changes on this web page.

Figure 4.5—Settings Web Page

**Active Configuration:** Selects one of sixteen configurations to be applied to the force and torque readings. For more information on these configurations, refer to [Section 4.6—Configurations Web Page \(config.htm\)](#).

**Low-Pass Filter Cutoff Frequency:** Selects the cutoff frequency for low-pass filtering. Selecting **No Filter** disables low-pass filtering. For more information, refer to [Section 18.2—Transducer Data Filtering](#).

**Peaks Monitoring:** If enabled, each axis’s lowest and highest F/T values are saved as minimum and maximum peaks. The **Reset Peaks** button clears the peaks. The **Reset Peaks** button is on the *Snapshot* web page.

This feature can be useful to detect crashes, during teaching, or finding out how close the application gets to the transducer’s limits.

**Software Bias Vector:** This is the bias offset applied to the transducer strain gage readings. Clicking the **Bias** button on the *Snapshot* web page changes these values. This bias may be removed by setting the software bias vector to all zeros.

Note that the strain gage readings do not have a one to one correspondence to force and torque readings.

**User Authentication:** Allows a user name and password to be set for accessing all ATI Net F/T web pages except the *Welcome* web page. The password can be reset by flipping DIP switch 9 on and off 5 times with no more than two seconds between two consecutive “on” flips. After switched, the password field is blank and the user authentication is disabled until a password is entered.

## 4.5 Monitor Conditions Web Page (moncon.htm)

This webpage is to set-up Monitor Conditions. Monitor Conditions compare transducer readings to simple user-defined condition statements. When Monitor Conditions is enabled and a sample is read that satisfies one or more of the active Monitor Conditions, the user-defined output code are bitwise or'ed together to form the condition output (in practice, it is very unlikely that more than one condition sample will be satisfied in a single sample). The condition monitoring latch is then set, and condition monitoring is paused until a command to reset the condition monitoring latch is received. The condition output is available on the *Snapshot* web page.

When F/T Out-of-Range Monitoring is enabled, the Net F/T will set the relay output if the current F/T readings exceed the calibrated range. Monitor Conditions must be enabled.

When Status Word Monitoring is enabled, the Net F/T will set the relay output if any status errors are present. Monitor Conditions must be enabled.

When Gage Monitoring is enabled, the Net F/T will set the relay output if the absolute value of any individual gage exceeds the value in the Gage Count Threshold field. Monitor Conditions must be enabled.

Each condition can be configured for the following:

- the axis to monitor
- the type of comparison to perform
- the condition value to use for the comparison
- the output code to send when the comparison is true



Figure 4.6—Monitor Conditions Web Page

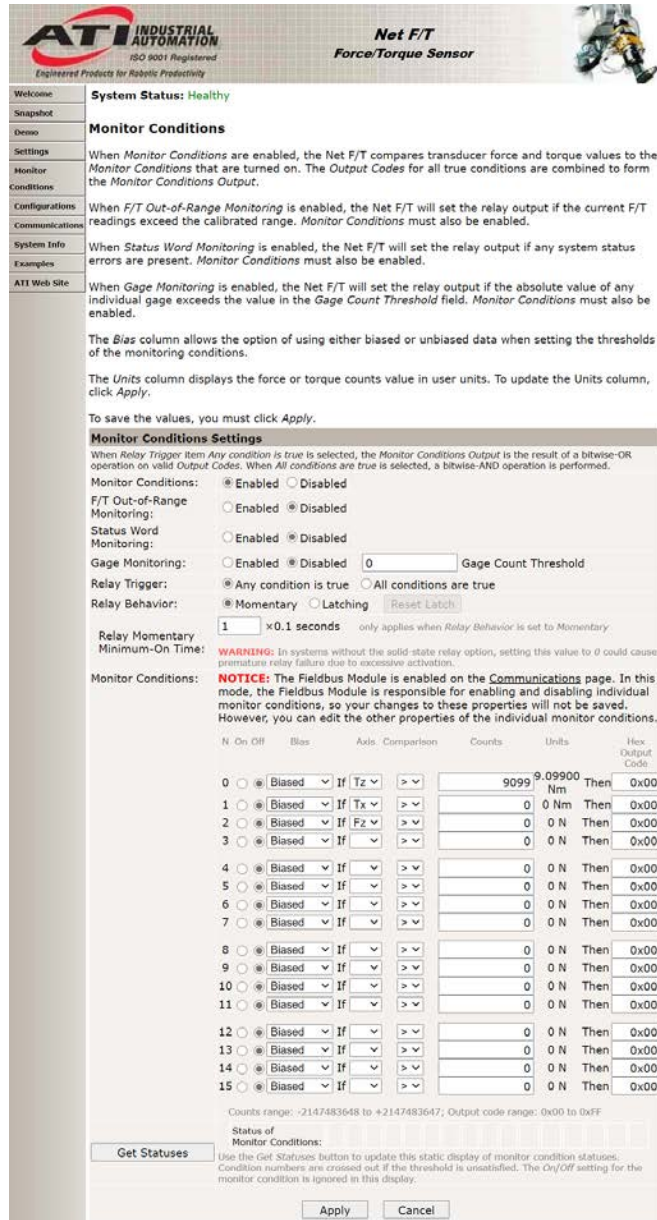

In case of any enabled Condition condition becoming true, the following occurs:

- The Condition’s output code is updated.
- Bit 16 of the system status code (see [Section 17.1—System Status Code](#)) sets to one.
- The Condition relay will close, connecting pin 3 to pin 4 of the Condition Relay connector ([Figure 4.7](#)).

Bit 16 and the Condition relay hold these states until a reset latch command is sent. Send the reset latch command by clicking the **Reset Latch** button on the *Snapshot* web page (refer to [Section 4.2—Snapshot Web Page \(rundata.htm\)](#)).

**Condition Condition Elements:**

- N: Statement number.
- On / Off: Selects which statements are to be included in the processing of conditions.
- Bias: Chooses whether the monitor condition evaluates the chosen axis before or after user bias is applied. If the “Biased” option is chosen, the axis has the current user bias subtracted before it is evaluated against the threshold. If the “Unbiased” option is chosen, the axis is compared to the threshold before the user bias is subtracted. Using unbiased data may be useful if you are trying to guard against overloading the sensor, since the unbiased data includes the weight of the application tooling, which still counts against the sensor’s overload capacity even when biased out by the user.
- Axis: Selects the axis to be used in the comparison statement. Available axes are:

Table 4.2—Monitor Conditions Statement Axis Selections	
Menu Value	Description
blank	Statement disabled
Fx	Fx axis
Fy	Fy axis
Fz	Fz axis
Tx	Tx axis
Ty	Ty axis
Tz	Tz axis

- Comparison: Selects the type of comparison to perform. Available comparisons are:

Table 4.3—Monitor Conditions Statement Comparison Selections	
Menu Value	Description
>	Greater Than
<	Less Than

- Counts: The loading level to be compared to the transducer reading. This value is displayed in the units of the active configuration after the *Apply* button is clicked.
- To determine the Counts value to use from a value in user units, multiply the value in user units by Counts per Force (or Counts per Torque if appropriate).

Example:

Desired Loading Level 6.25 N  
 Force Units: N (from *Configurations* web page)  
 Counts per Force value 1000000 (from *Configurations* web page)

Counts = Desired Loading Level × Counts per Force  
 = 6.25 N × 1000000 counts/N  
 = 6250000 counts

**NOTICE:** Comparison levels are stored as counts and only change when the user inputs new counts values. Changing the configuration or the force units or the torque units does not change or adjust the counts values.

- Units: Displays the counts value in the units of the active configuration. This value is only updated after the **Apply** button is clicked.
- Output Code: When this statement's comparison is found true, this 8-bit value is bitwise or'ed with the Output Code values of all other true statements to form the Condition output. Any set bits remain latched until Reset Latch is called. If no statements have been true, the Condition output is zero.  
 The value is displayed in hexadecimal in the format 0x00. Output Codes may be in the hexadecimal or decimal format.
- Reset Latch button: This button clears any Condition latching and reloads the Monitor Conditions page. If no Condition conditions remain true then Conditions Breached, Monitor Conditions Output, and Monitor Condition Latched are set to zero and the System Status: Condition Level Latched condition is cleared.

### 4.5.1 Condition Relay

The Condition relay closes its contacts when Monitor Condition Latched is true and allows external electrical equipment to react. Possible uses include control of E-stop circuits.

Relay operation is determined by the Relay Trigger, Relay Behavior, and Relay Momentary Minimum-On Time settings.

For increased reliability, it is best to monitor both the normally open (NO) and normally closed (NC) relay contacts. This allows detection of some cabling or relay issues.

The Condition relay contacts (NC, NO, and COM) are protected against overload by a resettable fuse, for electrical specifications, refer to [Section 18.3.3—Standard Condition Relay](#).

#### 4.5.1.1 Standard Net Box Condition Relay

The standard Net Box Condition relay is a mechanical relay used on 9105-NETB, and 9105-NETBA (The fieldbus Net Box has the solid-state relay described in [Section 4.5.1.2—Fieldbus Net Box and Optional Solid State Condition Relay](#)).

**Figure 4.7—Standard Net Box Condition Relay Connector Pin Assignment (Male-pin side view)**

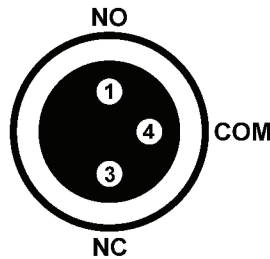

Pin	Name	Description
1	NO	Normally open connection
3	NC	Normally closed connection
4	Com	Common

 **CAUTION:** The solid-state relay connections are polarity dependent. A reverse-polarity connection could cause high current flow and damage the Net Box or user equipment.



**Figure 4.8—Example Circuit for Standard Net Box Condition Relay Monitoring**

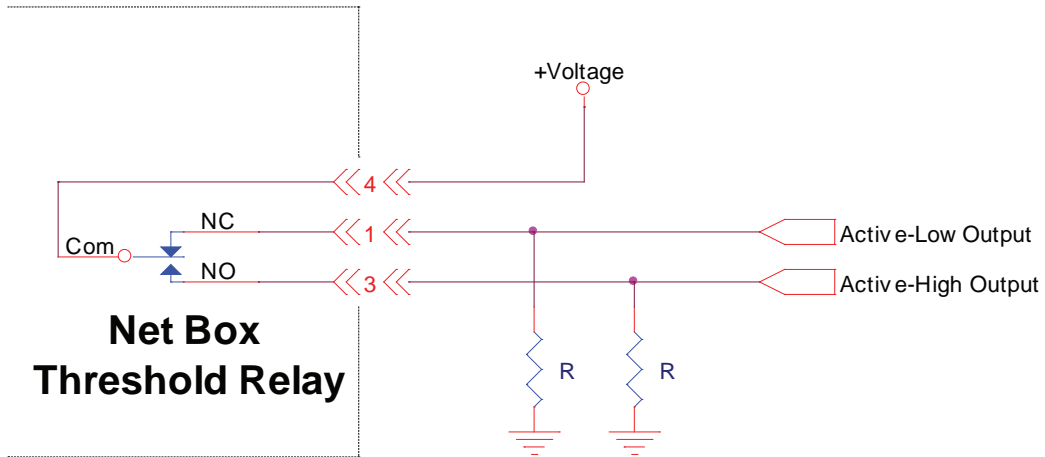

**Figure 4.9—Example Circuit for a Relay Interface**

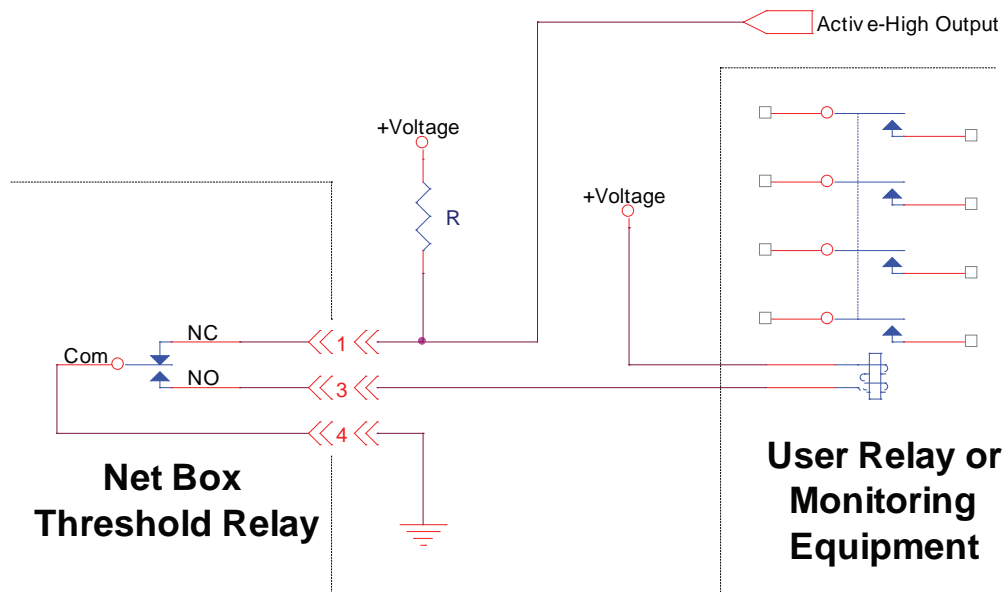

The standard Condition relay contacts (NC, NO, and Com) are protected against overload by a self-resetting fuse. The maximum guaranteed fuse hold current is 50 mA.

The relay will completely close its contacts within 6 ms.

### 4.5.1.2 Fieldbus Net Box and Optional Solid State Condition Relay

The solid-state relay is standard on 9105-CUSTOM-253, 9105-NETB-ZE3, 9105-NETB-PN and 9105-NETB-PN2, 9105-NETBA-PN and 9105-NETBA-PN2.

The optional solid-state Condition relay has a quicker activation time than the standard Condition relay. Since the solid-state Condition relay has no moving parts, wear is less likely.

Figure 4.10—Optional Solid State Relay Connector Pin Assignments (male-pin side view)

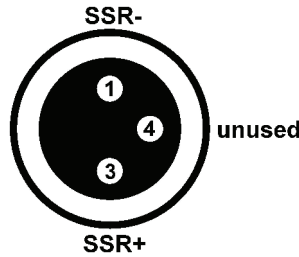

Figure 4.11—Solid-State Relay Equivalent Output Circuit

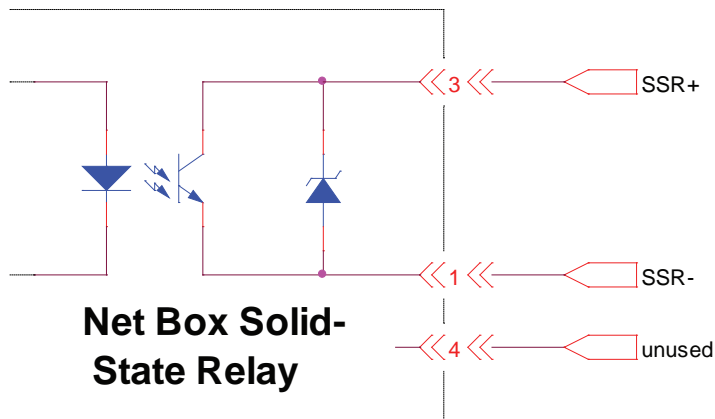
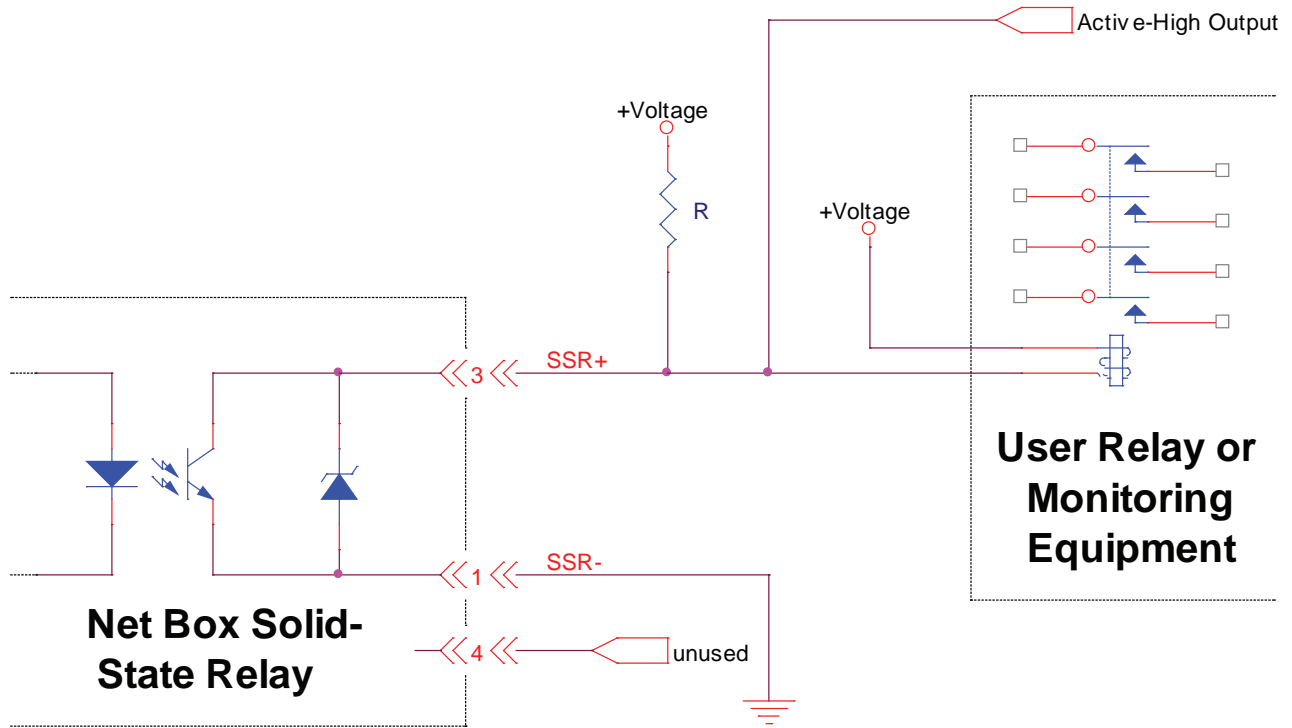

Table 4.5—Solid-State Relay Connector Pin Descriptions

Pin	Name	Description
1	SSR-	Solid-State Relay negative connection
3	SSR+	Solid-State Relay positive connection
4	—	unused

The solid-state relay can operate at up to 30 VDC and at a maximum current of 35 mA. The relay can turn on within 500  $\mu$ s of a trigger load. The output is reverse polarity protected to up to 1 A ( $V_r = 1.5$  V), 47 V. The maximum delay from Condition condition trigger to relay conduction is 500  $\mu$ s.

Figure 4.12—Example Connections to Solid-State Relay



## 4.6 Configurations Web Page (config.htm)

Specify the output parameters of the sensor system on this web page. Up to sixteen configurations can be defined. Changing configurations allows a different transducer calibration and tool transformation to be used. To implement changes on this page, click the **Apply** button.

Figure 4.13—Configurations Web Page

**ATI INDUSTRIAL AUTOMATION**  
 ISO 9001 Registered  
 Engineered Products for Robotic Productivity

**Net F/T**  
 Force/Torque Sensor

Welcome **System Status: Healthy**

Snapshot

Demo

Settings

Monitor

Conditions

Configurations

Communications

System Info

Examples

ATI Web Site

**Configurations**

User-defined configurations are displayed on this page. Use the *View Configuration* drop-down list and the *Go* button to display another configuration.

Each configuration loads a transducer calibration. A configuration can select the measurement system used for Force Units and Torque Units. A configuration can also apply a tool transformation to the output data.

After you have created a configuration, you can enable it on the [Settings](#) page.

To save the values, you must click *Apply*.

View Configuration: #1 - empty

**Configuration #1 (Active configuration)**

Configuration Name:  Maximum of 32 characters

Calibration Select: #1 - FT28948

Calibration Type: SI-16000-2000

Force Units:

Torque Units:

Counts per Force: 1000000

Counts per Torque: 1000000

Counts Per Force/Torque in 16-bit Mode:	Fx	Fy	Fz	Tx	Ty	Tz
	1023.5414	1023.5414	1023.5414	16129.032	16129.032	16129.032

Calibrated Sensing Range (Units):	Fx	Fy	Fz	Tx	Ty	Tz
	16	16	32	2	2	2

Calibrated sensing range values apply to the factory origin (without tool transformation).

Scaling Factor for DeviceNet and CAN:	Fx	Fy	Fz	Tx	Ty	Tz
	977	977	977	62	62	62

Using a tool transformation will change how transducer readings are reported and change the apparent sensing ranges and apparent resolutions.

A transform is a matrix operation that can be subdivided into a rotation and a displacement/translation. Since matrix multiplication is non-commutative, the order of rotations and translations matters. Thus, it is necessary to specify an order of operations, which has been set to the following:

1. X-Translation
2. Y-Translation
3. Z-Translation
4. X-Rotations
5. Y-Rotations
6. Z-Rotations

Tool Transform:

Distance Units:

Angle Units:

D = displacement (translation) in configured distance units, R = rotation in configured angle units.

Dx	Dy	Dz	Rx	Ry	Rz
0	0	0	0	0	0

User-defined Field #1:  Maximum of 16 characters

User-defined Field #2:  Maximum of 16 characters

View Configuration: Select the configuration to be viewed and edited. To update the web page with the selected configuration, click the **Go** button.

Configuration Name: Defines a name for the configuration.

**Calibration Select:** Selects the transducer calibration to use for a configuration. A transducer has at least one calibration. Many Net F/T systems only have one calibration available; if an invalid calibration is selected, an “Empty Calibration Selected” error occurs.

If a different calibration is selected, the values displayed in fields Calibration Type, Counts per Force, Counts per Torque, Calibrated Sensing Range, and Scaling Factor for DeviceNet and CAN are not updated until the **Apply** button is clicked.

**Calibration Type:** Displays the calibration associated with the selected calibration. If a new calibration is selected, this field will not be updated until the **Apply** button is clicked.

**Force Units:** Selects the force measurement units to use. Available force measurement units are:

Table 4.6—Force Unit Selections	
Menu Value	Description
lbf	Pound-force
N	Newtons
klbf	Kilopound-force
kN	Kilonewton
kgf	Kilogram-force
gf	Gram-force

If new force units are selected, the values displayed in fields Counts per Force and Calibrated Sensing Range are not updated until the **Apply** button is clicked.

**Torque Units:** Selects the torque measurement units to use. Available torque measurement units are:

Table 4.7—Torque Unit Selections	
Menu Value	Description
lbf-in	Pound-force-inch
lbf-ft	Pound-force-feet
Nm	Newton-meter
Nmm	Newton-millimeter
kgf-cm	Kilogram-force-centimeter
kNm	Kilonewton-meter

If new torque units are selected, the values displayed in fields Counts per Torque and Calibrated Sensing Range are not updated until the **Apply** button is clicked.

**Counts per Force:** Force values in counts are equal to the force values in selected units multiplied by this factor. The application program has to divide each force counts value by the Counts per Force value to obtain the real force data (refer to [Section 9.3—Calculating F/T Values for RDT](#) and [Section 13.2—Calculating F/T Values for CIP](#)).

If the new Force Units field has been selected, this field will not be updated until the **Apply** button is clicked.

**Counts per Torque:** Torque values in counts are equal to the torque values in selected units multiplied by this factor. The application program has to divide each torque counts value by the Counts per Torque value to obtain the real torque data (refer to [Section 9.3—Calculating F/T Values for RDT](#) and [Section 13.2—Calculating F/T Values for CIP](#)).  
 If the new Torque Units field has been selected, this field is not updated until the **Apply** button is clicked.

**Counts per Force/Torque in 16-bit Mode:** Shows the counts/unit used in the 16-bit interfaces (CAN, DeviceNet, TCP, and PROFINET interfaces).

**Calibrated Sensing Range:** The transducer is calibrated up to these values in the selected force and torque measurement units. This applies to single-axis load conditions at the factory origin (no tool transformation). For complex load conditions, refer to the F/T Transducer Manual ([9620-05-Transducer Section](#) manual).  
 If a new calibration is selected, a new force unit is select, or a new torque unit is selected, this field is not updated until the **Apply** button is clicked.

**Scaling Factor for DeviceNet and CAN:** In order to reduce the amount of data transmitted via DeviceNet or CAN Bus, the force and torque values are reduced to 16 bits using this factor (refer to [Section 13.2.2—DeviceNet](#) and [Section 14.5—Calculating F/T Values for CAN](#)).

**Tool Transform Distance Units:** This is the distance units used for the distance vector in the tool transformation. Available transform distance units are:

Table 4.8—Tool Transform Distance Unit Selections	
Menu Value	Description
In	inch
ft	foot
mm	millimeter
cm	centimeter
m	meter

To change the Tool Transform Distance Units does not change or rescale the tool transform values.

**Tool Transform Angle Units:** The angular units used for the rotation vector in the tool transformation. Available transform angle units are:

Table 4.9—Tool Transform Angle Unit Selections	
Menu Value	Description
degrees	degrees (°)
radians	radians

To change the Tool Transform Angle Units does not change or rescale the tool transform values.

Tool Transform: The tool transformation function allows measurement of the forces and torques at some point other than the origin of the transducer.

Forces and torques are by default reported with respect to the factory point of origin. The factory point of origin places the X, Y, and Z axes as shown on the transducer drawings on the [ATI website](#).

Tool transformations are particularly useful when this point is chosen as the point-of-contact between the robotic end-effector (tool) and the object being worked. A tool transformation can translate the reported origin a distance (Dx, Dy and Dz) from the factory origin and also rotate the reported origin (Rx, Ry and Rz) about the factory origin. A tool transformation allows a coordinate frame to be created that aligns resolved force/torque components with the natural axes of the task geometry.

To keep the transducer's point of origin at the factory-defined location, all tool transform values need to be zero. Descriptions of the values and the order in which the values are applied to the factory-defined point of origin are as follows:

Table 4.10—Tool Transformation Offsets		
Column	Description	Order
Dx	Distance to move X axis	1
Dy	Distance to move Y axis	2
Dz	Distance to move Z axis	3
Rx	Rotation angle about X axis	4
Ry	Rotation angle about Y axis	5
Rz	Rotation angle about Z axis	6

All transducer working specifications pertain to the factory point-of-origin only. This includes the transducer's range, resolution, and accuracy. The transducer working specifications at a customer-applied point-of-origin will differ from those at the factory point of-origin.

User-defined Field #1: Defines a short note for this configuration.

User-defined Field #2: Defines a second short note for this configuration.



## 4.7 Communication Settings Page (comm.htm)

View and set system networking options on this web page. Usually these settings are set once when the system is first installed and do not need to be changed later.

For information on setting the system to work with the network, refer to [Section 3—Getting Started](#).

Figure 4.14—Standard Net Box’s Communications Page

**ATI INDUSTRIAL AUTOMATION**  
 ISO 9001 Registered  
 Engineered Products for Robotic Productivity

**Net F/T**  
 Force/Torque Sensor

Welcome  
 Snapshot  
 Demo  
 Settings  
 Monitor Conditions  
 Configurations  
 Communications  
 System Info  
 Examples  
 ATI Web Site

**System Status:** Healthy

**Communications**

These settings control how the Net F/T communicates with external equipment. Most settings require the Net F/T to be powered off and then back on before they take effect.

To save the values, you must click *Apply*.

**Ethernet Network Settings**

DIP switch 9 must be *off* to enable IP Address Mode. If DIP switch 9 is *on*, then the IP address is set to 192.168.1.1 regardless of the *IP Address Mode* settings below. A LAN connection must be present at power up for DHCP to function. If DHCP is enabled and no DHCP server is found, then the static IP address will be used.

IP Address Mode:  DHCP  Static IP see above note regarding DIP switch 9

Static IP Address:

Static IP Subnet Mask:

Static IP Default Gateway:

EtherNet/IP Protocol:  Enabled  Disabled

Ethernet/IP O2T Data:  Enabled  Disabled

Ethernet/IP Data Format:  32-bit Signed Data  16-bit Unsigned Data

Ethernet MAC Address:

**Fieldbus Module Settings**

Starting in units shipped with firmware version 2.2.59, the PROFINET fieldbus module used in the Net F/T requires a newer GSDML file than the file used with previous firmware versions. Make sure you have the correct GSDML file for your unit. The GSDML file for the Net F/T is available on ATI's website. [Click this link to get the correct GSDML file.](#)

Fieldbus Module Firmware Name:

Fieldbus Module Firmware Version:

Fieldbus Module Enabled:  Enabled  Disabled

Fieldbus Module Output Byte Order:  Little Endian  Big Endian

**CAN Network Settings**

If power is not provided to the Pwr/CAN connector, then *CAN Bus Base Address*, *DeviceNet MAC ID*, and *Baud Rate* are not correctly reported and communications over the Pwr/CAN connector are not available.

Protocol:  CAN Bus  DeviceNet

CAN Bus Base Address:  set by DIP switches 1 to 6

DeviceNet MAC ID:  set by DIP switches 1 to 6 (inaccurate without DeviceNet connection)

Baud Rate:  kHz set by DIP switches 7 and 8

**Raw Data Transfer (RDT) Settings**

RDT data is routed through the local network and does not get routed through the default gateway.

RDT Interface:  Enabled  Disabled demo application requires RDT to be enabled

RDT Output Rate (1 to 7000):  Hz value may be rounded up; see manual for details

RDT Buffer Size (1 to 40):

Multi-Unit Synchronization:  Enabled  Disabled

Multi-Unit Id (1 to 9):

**Modbus TCP Settings**

Modbus Server:  Enabled  Disabled

Modbus Client:  Enabled  Disabled

Modbus Client's Tx Interval (ms):

Modbus Client's Server IP Address:

Modbus Client's Server Write Register:

Modbus Client's Server Read Register:

**NOTICE:** The Ethernet Network Settings only applies to the standard Ethernet and EtherNet/IP interfaces included in all Net Boxes. The Ethernet Network Settings do not apply to the additional fieldbus interface included in fieldbus Net Boxes.

### Ethernet Network Settings:

**IP Address Mode:** Controls how the Net F/T determines its IP Address. If DHCP is selected, it will obtain an IP address from the Ethernet network's DHCP server. If the Net Box does not receive an address from the DHCP server within 30 seconds after power up, it defaults to use the static IP settings. If Static IP is selected, the Static IP Address and Static IP Subnet Mask will be used for the IP address.

**NOTICE:** DHCP-assigned addresses are not permanent and may change if the Net F/T is disconnected from the network for a period of time. Users should contact their IT department for more information. Discover the changed IP address by following the instructions in [Section 6.1—Finding Net F/Ts on the Network](#).

Static IP addresses are often more desirable in permanent Net F/T installations because the address will not change.

**Static IP Address:** Sets the static IP address (refer to [Section 3.4—IP Address Configuration for Ethernet](#)). Users should contact their IT department for information on what static IP address to assign.

**Static IP Subnet Mask:** Sets the subnet mask portion of the IP address. Many networks use the default 255.255.255.0. Users should contact their IT department for information on what static IP subnet mask to assign.

**Static IP Default Gateway:** Sets the default gateway. Users should contact their IT department for information on what default gateway to assign.

**EtherNet/IP Protocol:** Controls whether or not the Net F/T uses EtherNet/IP. EtherNet/IP is only needed for industrial networks using the EtherNet/IP protocol. Most non-industrial applications leave EtherNet/IP disabled. DeviceNet protocol must be disabled when EtherNet/IP protocol is enabled.

**Ethernet/IP O2T Data:** If enabled, the Net F/T accepts a 4-byte output bitmap which is identical to the Profinet bitmap in [Table 15.3](#). If disabled, the Net F/T does not accept any Ethernet/IP output data.

**Ethernet/IP Data Format:** Changes the Ethernet/IP output data between the current 32-bit values, and 16-bit unsigned values. The 16-bit unsigned values use the same 16-bit scaling factor used by the DeviceNet, CAN, and TCP interface data (see [Figure 13.1](#)), and since they are unsigned, a “no load” value is reported as +32768 counts, a negative full-scale load is reported as approximately 0 counts, and a positive full-scale load is reported as approximately 65536 counts.

**Ethernet MAC Address:** The unique address given to this Net F/T at the time of manufacture. This address can be used to uniquely identify this Net F/T from other Net F/Ts and other Ethernet devices.

### Fieldbus Module Settings (only displays on fieldbus Net Boxes):

**Fieldbus Module Firmware:** Displays the type of fieldbus protocol supported by the fieldbus Net Box.

**Fieldbus Module Firmware Version:** Displays the version of installed firmware.

**Fieldbus Module Enabled:** If enabled, the Net Box supports the fieldbus protocol listed in Fieldbus Module Firmware. If disabled, then that fieldbus protocol is unavailable to the network.

**Fieldbus Module Output Byte Order:** If a fieldbus module is installed, adds option to select byte order (little-endian or big-endian). Only enabled if fieldbus module is installed.

### CAN Network Settings:

Protocol:	Controls which protocol will be used on the Pwr/CAN connector. When CAN Bus is selected the basic CAN protocol described in <a href="#">Section 14—CAN Bus Operation</a> is used. When DeviceNet is selected the DeviceNet-compatibility mode protocol described in <a href="#">Section 12—DeviceNet-Compatibility Mode Operation</a> is used. It is best to select CAN Bus when neither protocol is needed; otherwise a DeviceNet protocol failure will be signaled. EtherNet/IP protocol must be disabled when DeviceNet protocol is enabled.
CAN Bus Base Address:	Displays the base address to be used by the CAN bus protocol. For information on setting this address, refer to <a href="#">Section 3.9.2—Node Address</a> .
DeviceNet MAC ID:	Displays the DeviceNet MAC ID address to be used by the DeviceNet compatibility-mode protocol. For information on setting this address, see <a href="#">Section 3.9.2—Node Address</a> .
Baud Rate:	Displays the CAN bus baud rate used by the CAN network. For information on setting the baud rate, refer to <a href="#">Section 3.9.3—Baud Rate</a> .

**NOTICE:** The values displayed for CAN Bus Base Address, DeviceNet MAC ID, and Baud Rate are only valid if power is supplied to the Pwr/CAN connector. Otherwise indeterminate data is displayed.

### Raw Data Transfer (RDT) Settings:

RDT Interface:	If enabled, the Net Box establishes a point-to-point UDP connection to a host computer. In the RDT interface is described in detail. RDT data is routed through the local network and does not get routed through the default gateway (refer to <a href="#">Section 9—UDP Interface Using RDT</a> ).
RDT Output Rate:	The rate per second at which the Net Box sends streaming RDT data to a host. It can be adjusted in integer fractions of 7000 (e.g., $7000 \div 2 = 3500$ or $7000 \div 3 = 2333$ ). If a different sample rate is entered, the Net F/T will automatically change to the next higher possible sample rate.
RDT Buffer Size:	The RDT interface can operate in different modes. One of these is the Buffer Mode where the Net Box sends more than one data sample per package. Multiple data samples are buffered and sent in one packet. This reduces the amount of overhead data to be sent with the effect of reducing the overall network traffic. The number of data samples per packet is the Buffer Mode Size.

**Modbus TCP Settings:**

Modbus Server: The internal TCP Modbus Server is active whenever it is selected on the Modbus Setting portion of the *Communications* web page. The Modbus Server supports the following Modbus commands:

- Read Input Registers
- Read Holding Registers
- Write Single Register
- Write Multiple Registers
- Read/Write Multiple Registers

Modbus Client: The internal TCP Modbus Client is active whenever selected on the Modbus Setting portion of the *Communications* web page.

Every “Modbus Client’s Tx Interval” milliseconds the Modbus Client uses the Modbus Read/Write Multiple Registers command to write its internal registers 0 through 26 to the remote Modbus Server registers starting with the register number specified by “Modbus Client’s Server Write Register”. In the same command, it also reads its internal registers 27 to 42 from those in the remote Modbus Server starting with the register number specified by Modbus Client’s Server Read Register. The remote Modbus Server is located at the Modbus Client’s Server IP Address.

If the remote Modbus Server reports that it does not support the Modbus Read/Write Multiple Registers command, the register transfers are then completed via the Read Holding Registers and the Write Multiple Registers commands.

### 4.7.1 TCP Modbus Register Map

Table 4.11—TCP Modbus Register Map			
NetBox Register	Corresponding Robot Register	Direction (from NetBox)	Function
0	128	Out	Force X
1	129	Out	Force Y
2	130	Out	Force Z
3	131	Out	Torque X
4	132	Out	Torque Y
5	133	Out	Torque Z
6	134	Out	Status MSB
7	135	Out	Status LSB
8	136	Out	Gage 0
9	137	Out	Gage 1
10	138	Out	Gage 2
11	139	Out	Gage 3
12	140	Out	Gage 4
13	141	Out	Gage 5
14	142	Out	Force Units
15	143	Out	Torque Units
16	144	Out	Scale Factor 0
17	145	Out	Scale Factor 1
18	146	Out	Scale Factor 2
19	147	Out	Scale Factor 3
20	148	Out	Scale Factor 4
21	149	Out	Scale Factor 5
22	150	Out	Counts per Force MSW
23	151	Out	Counts per Force LSW
24	152	Out	Counts per Torque MSW
25	153	Out	Counts per Torque LSW
26	154	Out	Sequence Number
27	155	In	System Commands
28	156	In	Transform Distance Units
29	157	In	Transform Angle Units
30	158	In	Dx * 100
31	159	In	Dy * 100
32	160	In	Dz * 100
33	161	In	Rx * 100
34	162	In	Ry * 100
35	163	In	Rz * 100
36	164	In	MCEnable LSW
37	165	In	MCEnable MSW
38	166	In	WMC index
39	167	In	WMC axis
40	168	In	WMC output code
41	169	In	WMC comparison
42	170	In	WMC compare value

Note: The choice of writing NetBox registers 0 to 26 to UR registers 128 to 154 (and of reading UR registers 155 to 170 into NetBox registers 27 to 42) was arbitrary and could have used any available set of contiguous UR registers of the same length. If Modbus register assignments are changed, make the corresponding register number changes in the Demo programs.

## 4.8 System Information Web Page (manuf.htm)

The *System Information* web page shows a summary of the system's current state. This page is used for troubleshooting by ATI Industrial Automation. For status codes, refer to [Section 17.1—System Status Code](#).

Figure 4.15—System Information Web Page

**ATI INDUSTRIAL AUTOMATION**  
 ISO 9001 Registered  
 Engineered Products for Robotic Productivity

**Net F/T**  
 Force/Torque Sensor

Welcome **System Status: Healthy**

Snapshot  
 Demo  
 Settings  
 Monitor Conditions  
 Configurations  
 Communications  
 System Info  
 Examples  
 ATI Web Site

**System Information**

This is a summary of the system's current state. This information may be helpful during troubleshooting.

**Transducer**

Strain Gage Values:

G0	G1	G2	G3	G4	G5
-2729	-788	-5192	-19287	924	-8429

Bias Values:

G0	G1	G2	G3	G4	G5
0	0	0	0	0	0

Force/Torque Counts:

Fx	Fy	Fz	Tx	Ty	Tz
-7668672	-10451541	-6841400	-1014379	402119	1667114
-7704022	-10463067	-6904742	-1019023	399771	1662477
-7655503	-10434133	-6760070	-1013494	404622	1670335

Force/Torque Units:

Fx	Fy	Fz	Tx	Ty	Tz
-7.670	-10.44	-6.862	-1.017	0.4019	1.6671
-7.704	-10.46	-6.904	-1.019	0.3997	1.6624
-7.655	-10.43	-6.760	-1.013	0.4046	1.6703

Minimum Peak Counts:

Fx	Fy	Fz	Tx	Ty	Tz
105698	4029	121797	5640207	-16468	-5562394
62312	-6487301	149156	3255615	-62894	3233017
7893051	19280	7758089	55470	7505024	13381
4788	-300667	693324	158236	-672164	150548
-807844	-2790	404082	-259641	408930	260392
-1255	-478776	-7091	-480539	-4436	-472140

Maximum Peak Counts:

Fx	Fy	Fz	Tx	Ty	Tz
105698	4029	121797	5640207	-16468	-5562394
62312	-6487301	149156	3255615	-62894	3233017
7893051	19280	7758089	55470	7505024	13381
4788	-300667	693324	158236	-672164	150548
-807844	-2790	404082	-259641	408930	260392
-1255	-478776	-7091	-480539	-4436	-472140

Run-time Matrix:

	G0	G1	G2	G3	G4	G5
Fx	105698	4029	121797	5640207	-16468	-5562394
Fy	-62312	-6487301	149156	3255615	-62894	3233017
Fz	7893051	19280	7758089	55470	7505024	13381
Tx	4788	-300667	693324	158236	-672164	150548
Ty	-807844	-2790	404082	-259641	408930	260392
Tz	-1255	-478776	-7091	-480539	-4436	-472140

**Summary of Calibrations and Configurations**

Active Configuration: #1: empty  
 Using Calibration: #1: FT19545

Calibrations			Configurations	
Index	Serial Number	Part Number	Index (Calibration Index)	Description
1	FT28948	SI-16000-2000	1	(1) empty
2	FT28949	SI-4000-500	2	(1) empty
3	FT0000	empty	3	(1) empty
4	FT0000	empty	4	(1) empty
5	FT0000	empty	5	(1) empty
6	FT0000	empty	6	(1) empty
7	FT0000	empty	7	(1) empty
8	FT0000	empty	8	(1) empty
9	FT0000	empty	9	(1) empty
10	FT0000	empty	10	(1) empty
11	FT0000	empty	11	(1) empty
12	FT0000	empty	12	(1) empty
13	FT0000	empty	13	(1) empty
14	FT0000	empty	14	(1) empty
15	FT0000	empty	15	(1) empty
16	FT0000	empty	16	(1) empty

**Digital Board**

Status Word: 0x00000000  
 Ethernet MAC Address: 00:16:BD:00:21:22  
 Serial Number: LOT 2634  
 2.2.89  
 Firmware Revision: Jul 30 2021  
 ATI Net F/T  
 Hardware Revision: 02

Diagnostic ADC Readings:

	0	1	2	3	4	5	6	7
	0	358	378	847	790	389	512	177

Hardware Product Code: 2

**Analog Board**

Power Up Status Word: 0x0000  
 Serial Number: untested  
 Firmware Revision: 2.0.3  
 Hardware Revision: untested  
 Location: untested

**Analog Board Link**

Rx Bytes (config): 6071  
 Rx packets (streaming): 1854712  
 Rx Framing Errors: 0  
 Rx Parity Errors: 0  
 Rx Events: 6071  
 Tx Bytes: 913



## 4.9 Examples Web Page (output.htm)

The *Examples* web page shows how to interpret the bytes in the data packets exchanged over each type of interface. It includes a discussion of unsigned vs. signed integers and byte ordering (endianness). It lists example data packets for each supported interface showing how to interpret the bytes in the data packets.

Figure 4.16—Examples Web Page

**ATi INDUSTRIAL AUTOMATION**  
 ISO 9001 Registered  
 Engineered Products for Robotic Productivity

**Net F/T**  
 Force/Torque Sensor

**Net F/T Interface Output Examples**

This page provides examples of data formatting for the various communication interfaces in the Net F/T.

**Definitions**

**Unsigned**  
 An unsigned integer can only represent 0 and positive numbers. This means a 16-bit unsigned integer can represent any number from 0 -  $2^{16}-1$  (0-65535).

**Signed**  
 A signed integer can represent negative, 0, and positive numbers. To do this we basically use the leftmost bit to represent the negative sign. This means a 16-bit signed integer can represent any positive number from 0 -  $2^{15}-1$  (0 - 32767) or it can represent any negative number from -1 -  $-2^{15}$  (-1 - -32768).

**Big-Endian**  
 The data bytes are ordered with the most-significant byte first. If the bytes 0x12 and 0x34 are received in that order, then the resulting 16-bit value is 0x1234.

**Little-Endian**  
 The data bytes are ordered with the least-significant byte first. If the bytes 0x12 and 0x34 are received in that order, then the resulting 16-bit value is 0x3412.

**RDT**  
 RDT uses 32-bit signed big-endian (not byte-swapped) F/T counts

**RDT Request Format**

Byte Value	Contents
0	0x12 Request Header
1	0x34 (constant)
2	0x00 Command Code
3	0x02
4	0x00 Sample Count
5	0x00 (0 = Infinite)
6	0x00
7	0x00

**RDT Response Format**

Byte Value in Hex	Value in Counts	Contents
0	0x00	0 RDT Packet Sequence Number
1	0x00	
2	0x00	
3	0x00	
4	0x00	0 F/T Record Internal Sequence Number
5	0x00	
6	0x00	
7	0x00	
8	0x00	0 System Status Code
9	0x00	
10	0x00	
11	0x00	
12	0xFF	-25487 X-Axis Force (Fx)
13	0xFF	
14	0x9C	
15	0x71	
16	0x00	28089 Y-Axis Force (Fy)
17	0x00	
18	0x6D	
19	0xB9	
20	0xFF	-14 Z-Axis Force (Fz)
21	0xFF	
22	0xFF	
23	0xF2	
24	0x00	26626 X-Axis Torque (Tx)
25	0x00	
26	0x68	
27	0x02	
28	0xFF	-2686 Y-Axis Torque (Ty)
29	0xFF	
30	0xF5	
31	0x82	
32	0x00	10303 Z-Axis Torque (Tz)
33	0x00	
34	0x28	
35	0x3F	



Figure 4.17—Examples Web Page (Continued)

**TCP**

TCP uses 16-bit signed big-endian (not byte-swapped) F/T counts

**TCP Request Format**

Byte Value	Contents
0	0 Command Code
1	0 Reserved
2	0
3	0
4	0
5	0
6	0
7	0
8	0
9	0
10	0
11	0
12	0
13	0
14	0
15	0
16	0 Enable Monitor Conditions (0 = Disable All Monitor Conditions)
17	0 System Commands
18	0
19	0

**TCP Response Format**

Byte Value in Hex	Value in Counts	Contents
0	0x12	4660 Packet Header (Constant)
1	0x34	
2	0x00	0 System Status Code (All zeroes indicates "Healthy" status)
3	0x00	
4	0x9C	-25487 X-Axis Force (Fx)
5	0x71	
6	0x6D	28089 Y-Axis Force (Fy)
7	0xB9	
8	0xFF	-14 Z-Axis Force (Fz)
9	0xF2	
10	0x68	26626 X-Axis Torque (Tx)
11	0x02	
12	0xF5	-2686 Y-Axis Torque (Ty)
13	0x82	
14	0x28	10303 Z-Axis Torque (Tz)
15	0x3F	

**Ethernet/IP**

Ethernet/IP can use either 16-bit or 32-bit signed little-endian (byte-swapped) F/T counts

**Ethernet/IP Request Format**

Byte Value	Contents
0	0 Command Code
1	0 Select Configuration (Configuration 0)
2	0x0000 Monitor Conditions to Activate
3	

**Ethernet/IP Response Format (32-bit F/T Data)**

Byte Value in Hex	Value in Counts	Contents
0	0x00	0 System Status Code
1	0x00	
2	0x00	
3	0x00	
4	0x71	-25487 X-Axis Force (Fx)
5	0x9C	
6	0xFF	
7	0xFF	
8	0xB9	28089 Y-Axis Force (Fy)
9	0x6D	
10	0x00	
11	0x00	
12	0xF2	-14 Z-Axis Force (Fz)
13	0xFF	
14	0xFF	
15	0xFF	
16	0x02	26626 X-Axis Torque (Tx)
17	0x68	
18	0x00	
19	0x00	
20	0x82	-2686 Y-Axis Torque (Ty)
21	0xF5	
22	0xFF	
23	0xFF	
24	0x3F	10303 Z-Axis Torque (Tz)
25	0x28	
26	0x00	
27	0x00	

**DeviceNet**

DeviceNet uses 16-bit signed little-endian (byte-swapped) F/T counts

DeviceNet interface does not use output/consumed data for requests. All requests must be done via explicit messaging.

**Figure 4.18—Examples Web Page (Continued)**

**DeviceNet Response Format**

Byte	Value in Hex	Value in Counts	Contents
0	0x34	4660	Packet Header (Constant)
1	0x12		
2	0x71	-25487	X-Axis Force (Fx)
3	0x9C		
4	0xB9	28089	Y-Axis Force (Fy)
5	0x6D		
6	0xF2	-14	Z-Axis Force (Fz)
7	0xFF		
6	0x02	26626	X-Axis Torque (Tx)
9	0x68		
10	0x82	-2686	Y-Axis Torque (Ty)
11	0xF5		
12	0x3F	10303	Z-Axis Torque (Tz)
13	0x28		

**CAN Bus**

CAN Bus can use either 16-bit or 32-bit signed little-endian (byte-swapped) F/T counts, depending on the initial request to the Net F/T.

**CAN Bus Data Exchange (32-bit)**

Message to Net F/T	Response from Net F/T	Base Address	Data Length in Bytes	Bytes 0-3	Bytes 4-7
Request 32-bit Data	-	Base Address	1	0x01 (8-bit)	N/A
-	Fx and Tx Data	Base Address +1	8	Fx Value (32-bit)	Tx Value (32-bit)
-	Fy and Ty Data	Base Address +2	8	Fy Value (32-bit)	Ty Value (32-bit)
-	Fz and Tz Data	Base Address +3	8	Fz Value (32-bit)	Tz Value (32-bit)
-	Status and Sample Number	Base Address +4	8	System Status	Sample Number

**CAN Bus Data Exchange (16-bit)**

Message to Net F/T	Response from Net F/T	Base Address	Data Length in Bytes	Bytes 0-3	Bytes 4-7
Request 16-bit Data	-	Base Address	1	0x02 (8-bit)	N/A
-	Fx, Tx, Fy, Ty Data	Base Address +5	8	Fx Value (16-bit)	Fy Value (16-bit)
-	Fz and Tz Data, Status and Sample Number	Base Address +6	8	Tx Value (16-bit) Fz Value (16-bit) Tz Value (16-bit)	Ty Value (16-bit) System Status (16-bit) Sample Number (16-bit)

**PROFINET**

PROFINET data from the Net F/T contains 16-bit little-endian (byte-swapped) F/T data.

**PROFINET Response Format**

Byte	Value in Hex	Value in Counts	Contents
0	0x00	0	Status Word (bits 16-31)
1	0x00		
2	0x71	-25487	X-Axis Force (Fx)
3	0x9C		
4	0xB9	28089	Y-Axis Force (Fy)
5	0x6D		
6	0xF2	-14	Z-Axis Force (Fz)
7	0xFF		
6	0x02	26626	X-Axis Torque (Tx)
9	0x68		
10	0x82	-2686	Y-Axis Torque (Ty)
11	0xF5		
12	0x3F	10303	Z-Axis Torque (Tz)
13	0x28		
14	0x00	0	Sequence Number
15	0x00		

**Modbus**

The Modbus interface uses signed 16-bit big-endian (not byte-swapped) data.

**Modbus Register Map**

NetBox Register	Corresponding Robot Register	Direction	Function (from NetBox)
0	128	Out	Force X
1	129	Out	Force Y
2	130	Out	Force Z
3	131	Out	Torque X
4	132	Out	Torque Y
5	133	Out	Torque Z
6	134	Out	Status MSB
7	135	Out	Status LSB
8	136	Out	Gage 0
9	137	Out	Gage 1
10	138	Out	Gage 2
11	139	Out	Gage 3
12	140	Out	Gage 4
13	141	Out	Gage 5
14	142	Out	Force Units
15	143	Out	Torque Units
16	144	Out	Scale Factor 0
17	145	Out	Scale Factor 1
18	146	Out	Scale Factor 2
19	147	Out	Scale Factor 3

**Figure 4.19—Examples Web Page (Continued)**

20	148	Out	Scale Factor 4
21	149	Out	Scale Factor 5
22	150	Out	Counts per Force MSW
23	151	Out	Counts per Force LSW
24	152	Out	Counts per Torque MSW
25	153	Out	Counts per Torque LSW
26	154	Out	Sequence Number
27	155	In	System Commands
28	156	In	Transform Distance Units
29	157	In	Transform Angle Units
30	158	In	Dx * 100
31	159	In	Dy * 100
32	160	In	Dz * 100
33	161	In	Rx * 100
34	162	In	Ry * 100
35	163	In	Rz * 100
36	164	In	MCEnable LSW
37	165	In	MCEnable MSW
38	166	In	WMC Index
39	167	In	WMC Axis
40	168	In	WMC Output Code
41	169	In	WMC Comparison
42	170	In	WMC Compare Value

#### 4.10 ATI Web Site Menu Item

Select this link to go to the ATI Industrial Automation website. The Net F/T's Ethernet network must be connected to the Internet to reach the website.

## 5. Java Demo Application

The Java demo application provides a simple interface to view and collect F/T data from a connected computer. The computer must have Java version 6.0 (runtime 1.6.0) or later installed (Java can be downloaded from [www.java.com/getjava](http://www.java.com/getjava).)

### 5.1 Starting the Demo

The demo can be downloaded from the *ATI Demo* web page (refer to [Section 4.3—Demo Web Page \(demo.htm\)](#)). Click the **Download Demo Application** button and follow the browser's instructions. The file ATINetFT.jar downloads. If the browser does not automatically run the downloaded file, manually open the file on the computer.

Figure 5.1—Demo Web Page

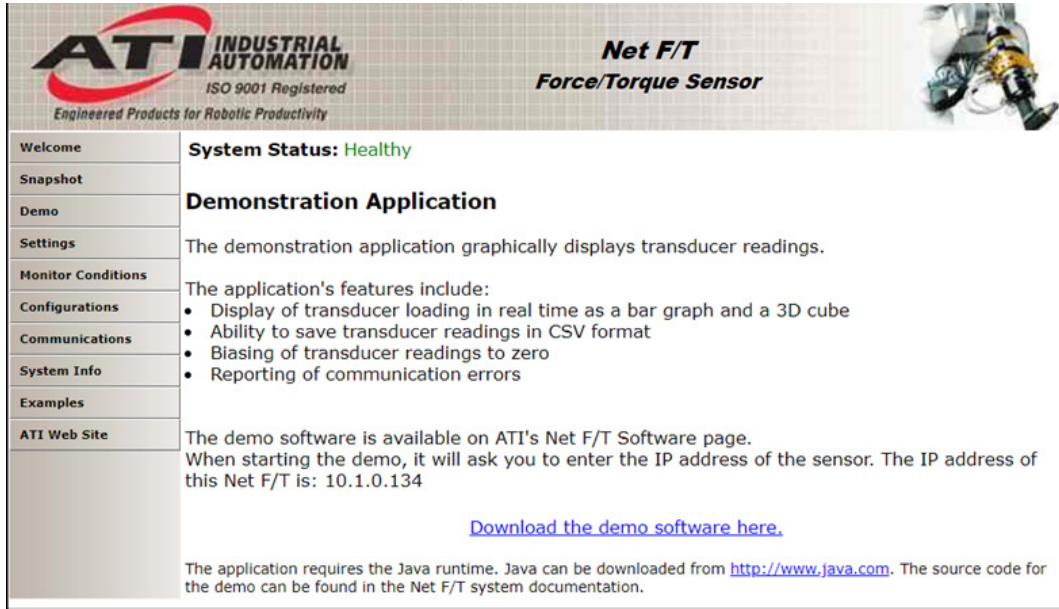

**NOTICE:** The Java Demo requires the Net F/T to have RDT Interface enabled. RDT is enabled in the Net F/T by default. See [Section 4.7—Communication Settings Page \(comm.htm\)](#) for information on RDT settings.

The demo program opens with the following window:

Figure 5.2—Net Box IP Address Request

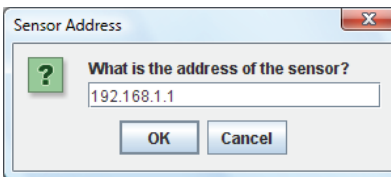

If the window does not appear, it may be hidden under the browser window. In this case, minimize the browser window to locate the address request window.

Type the IP address of the Net Box. The IP address of the Net F/T is displayed on the *Demo* web page in the paragraph above the **Download Demo Application** button. The main window of the Java Demo application should open.

The first time the demo is used it may trigger a firewall alert which is a normal response for any program using the network. In this case it is necessary to override the firewall and allow the program to use network connections. If the firewall is allowed to block connections, the utility cannot contact the Net F/T, and the users IT department must undo the firewall block.

Figure 5.3—Windows Vista Firewall Alert

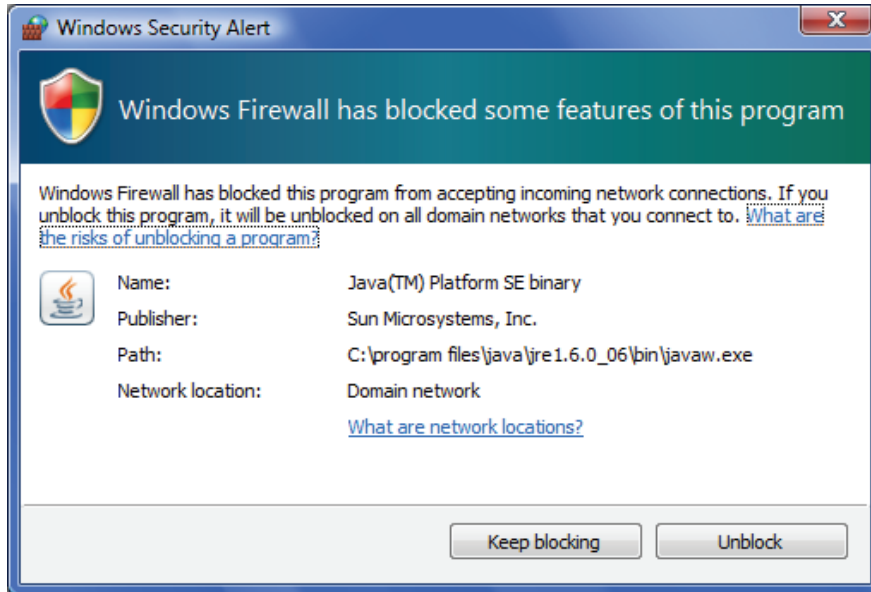
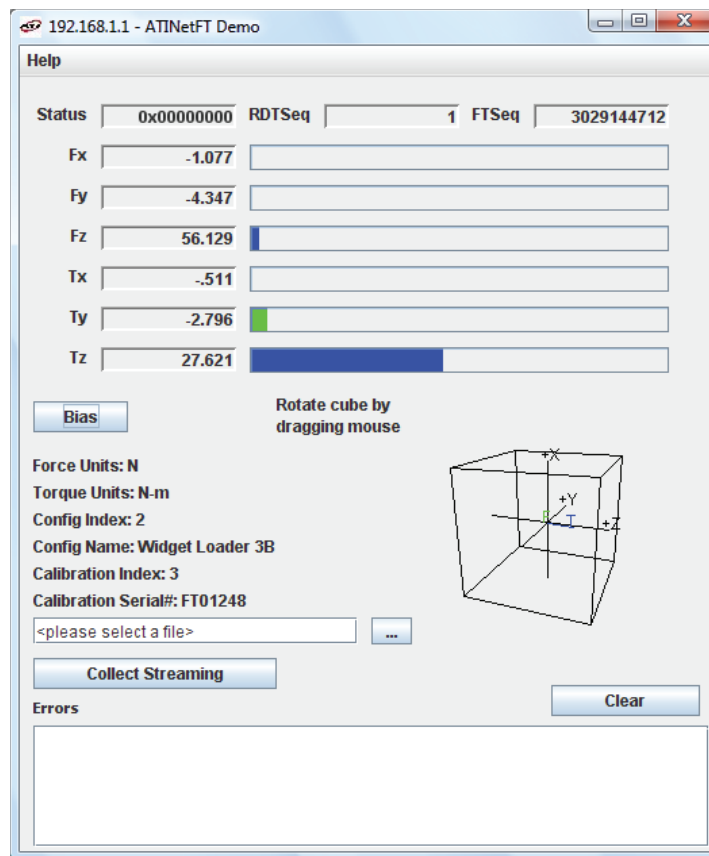

Figure 5.4—Java Demo Application



If the demo is unable to make contact with the Net F/T, the F/T values display zero, and the force units and other configuration-related items each display a question mark.

## 5.2 Data Display with the Demo

The main screen features a live display of the current F/T data, sequence numbers, and status code. During normal operation the application requests single records, so the RDT sequence remains constant.

### 5.3 Collecting Data with the Demo

To collect data, first select a file to save the data in, either by pressing the “...” button to the right of the file selection field, or by directly typing the file path into the field. Once the file is selected, click the **Start Collecting** button. The application sends a request for high-speed data to the Net F/T sensor system. The RDT sequence is incrementing now because the application requests more than a single record when in high-speed mode.

The measurement data are stored in comma-separated value format (CSV) so it can be read by spreadsheets and data-analysis programs. Name this file with a .CSV extension; open the file with a double-click.

If collecting large amounts of data, understand any limitations of the spreadsheet or data analysis program, for example: some interfaces may have a limit on the number of rows it can collect and compute data.

**Figure 5.5—Java Demo Application while Collecting Data**

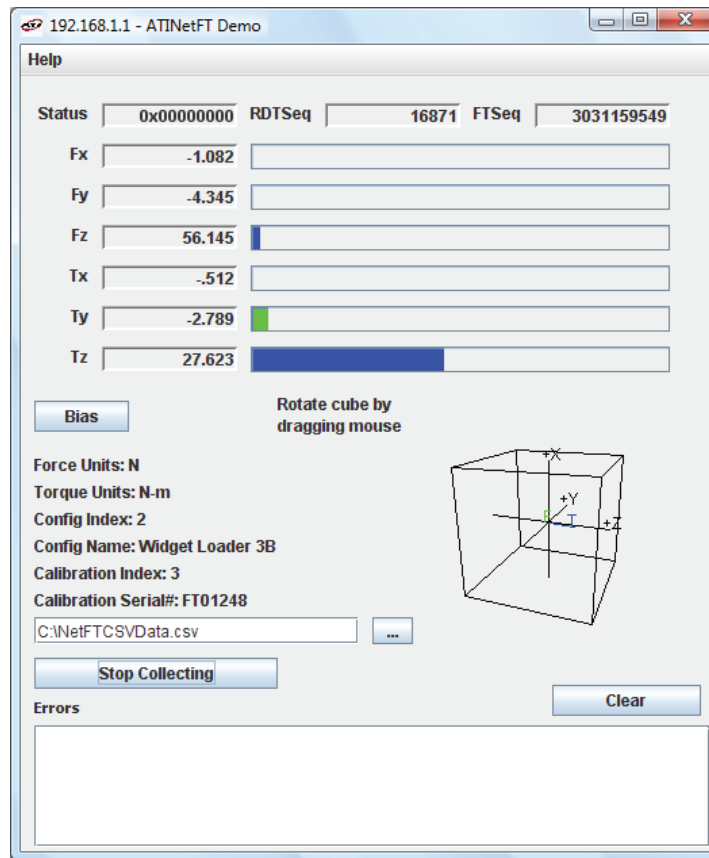

To stop collecting data, click the **Stop Collecting** button (the **Collect Streaming** button changes to **Stop Collecting** during collections).

Information stored in the CSV file is organized as follows:

Line 1: Start Time. The date and time when the measurement was started.

Line 2: RDT Sample Rate. The speed (in samples per second) at which the measurement data was sent from the Net F/T to the host computer. The speed is the RDT Output Rate defined on the *Communications* web page.

Note: If the sample rate is changed after start of the demo program, this value is not be updated.

Line 3: Force Units. This is the force unit selected on the *Configuration* page.

- Line 4: Counts per Unit Force. All force values Fx, Fy, Fz in the CSV file must be divided by this number to get the force values in the selected unit.
- Line 5: Torque Units. This is the torque selected on the Configuration page.
- Line 6: Counts per Unit Torque. All torque values Tx, Ty, Tz in the CSV file must be divided by this number to get the torque values in the selected unit.
- Line 7: Header Row. This row names each of the columns of CSV data.

Table 5.1—CSV File Column Headings										
Column:	A	B	C	D	E	F	G	H	I	J
Name:	Status (hex)	RDT Sequence	F/T Sequence	Fx	Fy	Fz	Tx	Ty	Tz	Time

Column A: Status (hex) is the 32-bit system status code for this row. Each bit signals a certain diagnostic condition. Normally this code is zero. A non-zero status code normally means that the Net F/T system needs attention. For a detailed description of the status code, refer to [Section 17.1—System Status Code](#).

Column B: RDT Sequence is a number that starts at one and is incremented with each set of data that is sent from the Net F/T to the host computer.  
 Elapsed measurement time can be found with using the formula:

$$\text{Elapsed Measurement Time} = \frac{\text{RDT Sequence Number}}{\text{RDT Sample Rate}}$$

Missing sequences indicate that data packages were lost. To avoid lost samples, refer to [Section 16.1—Improving Ethernet Throughput](#).

Column C: F/T Sequence is a number that is incremented with each new F/T measurement. The Net F/T measures at a constant rate of 7000 samples per second.

Column D: Fx is the Fx axis reading in counts.

Column E: Fy is the Fy axis reading in counts.

Column F: Fz is the Fz axis reading in counts.

Column G: Tx is the Tx axis reading in counts.

Column H: Ty is the Ty axis reading in counts.

Column I: Tz is the Tz axis reading in counts.

Column J: Time is the time the demo program received the data row from the Net F/T. This time stamp is created by the computer and is limited to the clock resolution of the computer.



Figure 5.6—Sample Data Opened in Spreadsheet

	A	B	C	D	E	F	G	H	I	J
1	Start Time: 10/28/08 4:45 PM									
2	RDT Sample Rate: 7000									
3	Force Units: N									
4	Counts per Unit Force: 1000000.0									
5	Torque Units: N-m									
6	Counts per Unit Torque: 1000000.0									
7	Status (hex)	RDTSequence	F/T Sequence	Fx	Fy	Fz	Tx	Ty	Tz	Time
8	0x80010000	1	3031142679	-1082088	-4344421	56145954	-512907	-2789325	27622278	Tue Oct 28 16:45:31 EDT 2008
9	0x80010000	2	3031142680	-1082080	-4344397	56146508	-512897	-2790736	27622288	Tue Oct 28 16:45:31 EDT 2008
10	0x80010000	3	3031142681	-1082060	-4343688	56146485	-513175	-2791845	27621563	Tue Oct 28 16:45:31 EDT 2008
11	0x80010000	4	3031142682	-1082341	-4342832	56147539	-513359	-2791420	27621240	Tue Oct 28 16:45:31 EDT 2008
12	0x80010000	5	3031142683	-1082371	-4342861	56148597	-512138	-2790008	27621264	Tue Oct 28 16:45:31 EDT 2008
13	0x80010000	6	3031142684	-1082385	-4342524	56148628	-511978	-2790022	27621981	Tue Oct 28 16:45:31 EDT 2008
14	0x80010000	7	3031142685	-1082389	-4342191	56148118	-512436	-2789687	27622688	Tue Oct 28 16:45:31 EDT 2008
15	0x80010000	8	3031142686	-1082363	-4341816	56149196	-512870	-2791481	27622352	Tue Oct 28 16:45:31 EDT 2008
16	0x80010000	9	3031142687	-1082350	-4342498	56149183	-513193	-2791443	27622000	Tue Oct 28 16:45:31 EDT 2008
17	0x80010000	10	3031142688	-1082658	-4343039	56148680	-513432	-2789853	27623085	Tue Oct 28 16:45:31 EDT 2008
18	0x80010000	11	3031142689	-1082649	-4343057	56148669	-514051	-2788802	27623093	Tue Oct 28 16:45:31 EDT 2008
19	0x80010000	12	3031142690	-1082364	-4342864	56147033	-513374	-2790000	27622309	Tue Oct 28 16:45:31 EDT 2008
20	0x80010000	13	3031142691	-1081778	-4342833	56145442	-513406	-2792379	27622237	Tue Oct 28 16:45:31 EDT 2008
21	0x80010000	14	3031142692	-1081805	-4343552	56144381	-513136	-2790561	27622936	Tue Oct 28 16:45:31 EDT 2008
22	0x80010000	15	3031142693	-1081820	-4344608	56142267	-513644	-2789069	27623972	Tue Oct 28 16:45:31 EDT 2008
23	0x80010000	16	3031142694	-1082089	-4345096	56141691	-513861	-2789611	27622892	Tue Oct 28 16:45:31 EDT 2008
24	0x80010000	17	3031142695	-1082344	-4345231	56143795	-513900	-2790895	27621519	Tue Oct 28 16:45:31 EDT 2008
25	0x80010000	18	3031142696	-1082342	-4345217	56143265	-513897	-2791596	27621503	Tue Oct 28 16:45:31 EDT 2008
26	0x80010000	19	3031142697	-1081777	-4345564	56142209	-513490	-2792190	27621809	Tue Oct 28 16:45:31 EDT 2008
27	0x80010000	20	3031142698	-1081488	-4346106	56141657	-513765	-2790886	27621793	Tue Oct 28 16:45:31 EDT 2008

#### 5.4 The Errors Display of the Demo

The error list at the bottom of the screen keeps track of errors that have occurred and the times they occurred, for example, refer to [Figure 5.7](#). For help with error messages, refer to [Table 17.5](#). If there is excessive IO Exception: Receive timed out errors, refer [Section 16.1—Improving Ethernet Throughput](#).

Figure 5.7—Java Demo Application with an Error Message

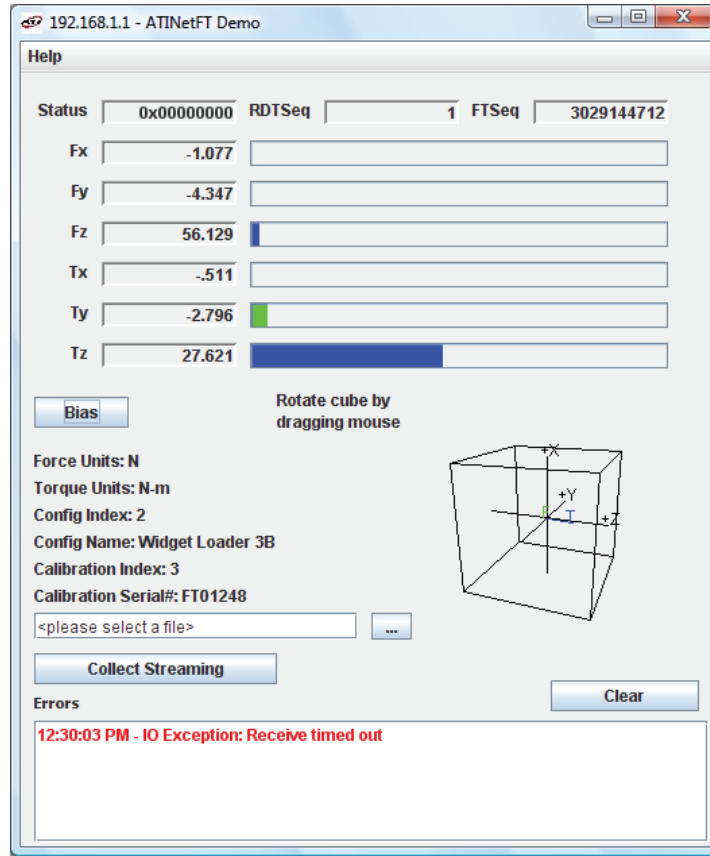

## 5.5 Developing a Custom Java Application

Experienced Java programmers can develop Net F/T applications using the files located at: [https://www.ati-ia.com/Products/ft/software/net\\_ft\\_software.aspx](https://www.ati-ia.com/Products/ft/software/net_ft_software.aspx). The source code for the Java demo is included in the downloadable directory.

## 6. Net F/T Configuration Utility

The *Net F/T Configuration Utility* is a Windows program that can find Net F/Ts on an Ethernet network, back-up configurations to a computer, restore configurations, and display saved configuration files.

The utility's installation package is in the *Configuration Utilities* directory that can be downloaded at: [https://www.ati-ia.com/Products/ft/software/net\\_ft\\_software.aspx](https://www.ati-ia.com/Products/ft/software/net_ft_software.aspx). Install the file by opening the *NetFT\_Configuration\_Utility\_Setup.msi* file. The utility is installed within the *ATI Industrial Automation Item* in the program list of Windows' **Start** menu.

### 6.1 Finding Net F/Ts on the Network

Launch *Net F/T Configuration Utility*. Click the **Find Net F/T** button.

Figure 6.1—Net F/T Configuration Utility

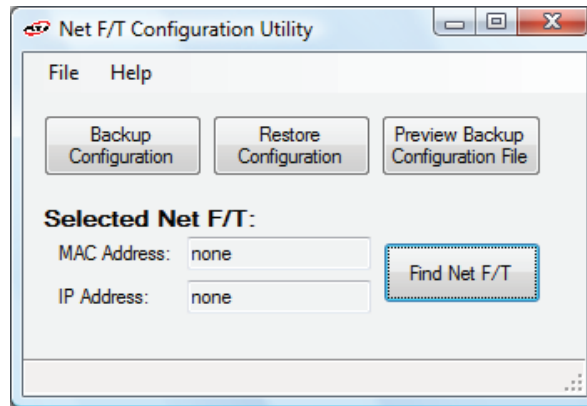

If the system has multiple connections to Ethernet a **Select Connection** window appears. If this is the case, click on the entry 192.168.1.100, and then click **OK**.

Figure 6.2—Selecting an Ethernet Connection

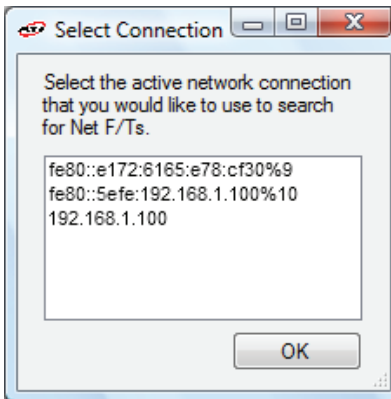

The first time the utility is used it may trigger a firewall alert and is a normal response for any program that uses the network. In this case override the firewall to allow the program to use network connections. If the firewall is told to block connections the utility is not able to contact the Net F/T. In this case, the users IT department must undo the firewall block.

If the firewall alert appears, it is unlikely that the utility found a Net F/Ts during that search. In this case, click the **Find Net F/T** button again and start over.

Figure 6.3—Windows Vista Firewall Alert

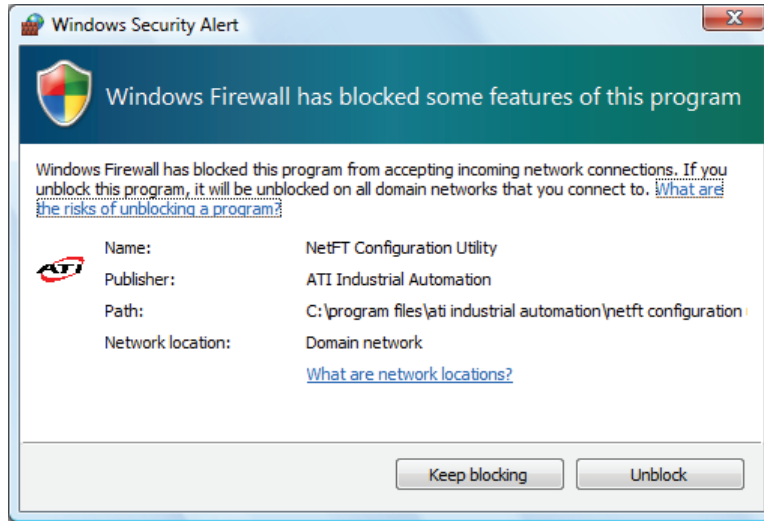

After a slight delay, the program reports back all Net F/Ts found on the network(s). Locate the line that has a MAC ID that matches the MAC ID printed on the Net Box and remember the IP address listed.

Note that the MAC ID listed may have a different format from the Net Box's printed label. In the following example, [Figure 6.4](#), the MAC ID is 00-16-BD-00-00-00, which matches the printed label MAC ID: 0016BD000000 and the IP address is 192.168.1.1.

Figure 6.4—Net F/Ts Found

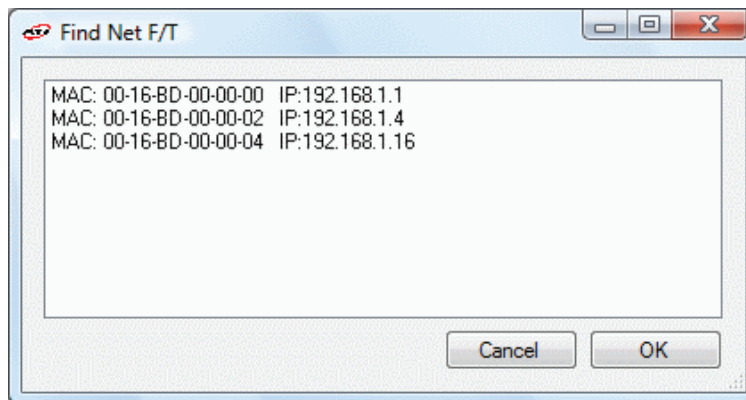

The IP address discovered is the address assigned by the DHCP server. Use this address to communicate with the Net F/T. Click on this line and then click on **OK**.

**NOTICE:** If the *Net FT Configuration Utility* found the Net F/T, but the internet browser is unable to open the found IP address, clear previous device entries from the computer's ARP table by restarting the computer or, with administrative privileges, by going to the computer's **Start** menu, selecting **Run...**, and typing `arp -d *`.

This step should only be necessary if another device previously occupied the same IP address that the Net F/T is now using.

**NOTICE:** IP addresses assigned by a DHCP server are not permanent and may change if the Net F/T is disconnected from the network for a period of time. Users should contact their IT department for more information.

## 6.2 Backing Up a Configuration to a Computer

The *Net F/T Configuration Utility* can read the configurations stored in a Net F/T and store them on the local computer. A replacement Net F/T can be easily be set-up to replace a damaged Net F/T by restoring a previously backed up configuration file to the new Net F/T. The configuration file contains all user-settable Net F/T information.

To back-up a Net F/T, first launch *Net F/T Configuration Utility*. Select the desired Net F/T using the steps in [Section 6.1—Finding Net F/Ts on the Network](#).

Next, click on the **Backup Configuration** button to start the process. A save file dialog window appears. Select a location and file name for the configuration file and click **OK**.

The utility takes a few moments to save the information.

**Figure 6.5—Backup Configuration**

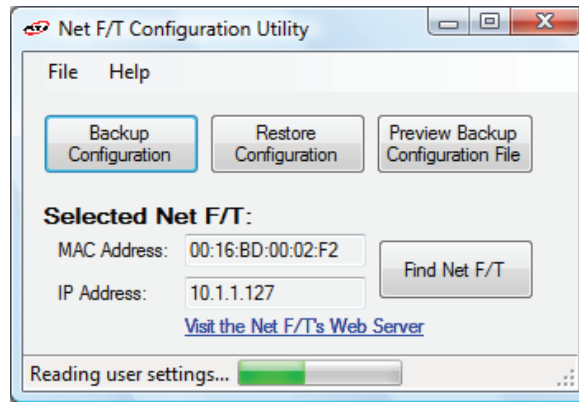

**NOTICE:** The NETBA type Net Boxes also contain calibration information for its transducer(s). This transducer calibration information is not saved by the utility. Replacement NETBA type Net Boxes will need to have the transducer calibrations loaded by another method. Contact ATI Industrial Automation for more information.

NETB type Net Boxes do not contain transducer calibration information.

## 6.3 Restoring a Saved Configuration

A previously-saved configuration file can be loaded into a Net F/T using the restore configuration feature.

To restore a configuration, first launch *Net F/T Configuration Utility*. Select the desired Net F/T using the steps in [Section 6.1—Finding Net F/Ts on the Network](#).

Next, click on the **Restore Configuration** button to start the process. An open file dialog window appears. Select a location and file name of the configuration file, and click **OK**.

A confirmation message appears before the configuration file is loaded into the Net F/T.

**Figure 6.6—Restore Confirmation**

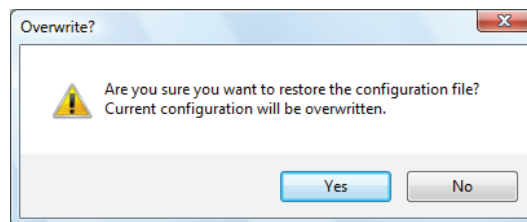

After the configuration file has been loaded, a completion message appears (refer to [Figure 6.7](#)). Click **OK** to dismiss the message. Power cycle the Net F/T to finish the restoration.

Figure 6.7—Restoration Complete

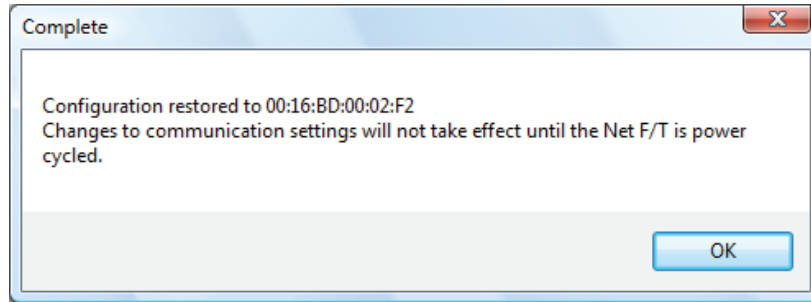

## 6.4 Inspecting a Saved Configuration File

Use the *Net F/T Configuration Utility* to view some of the information stored in a saved configuration file.

To view a configuration, first launch *Net F/T Configuration Utility*. Click the **Preview Backup Configuration File** button. An open file dialog window appears. Select a location and file name of the configuration file and click OK.

A preview window opens. When finished, click **Close** to dismiss the window.

Figure 6.8—Backup Configuration File Preview

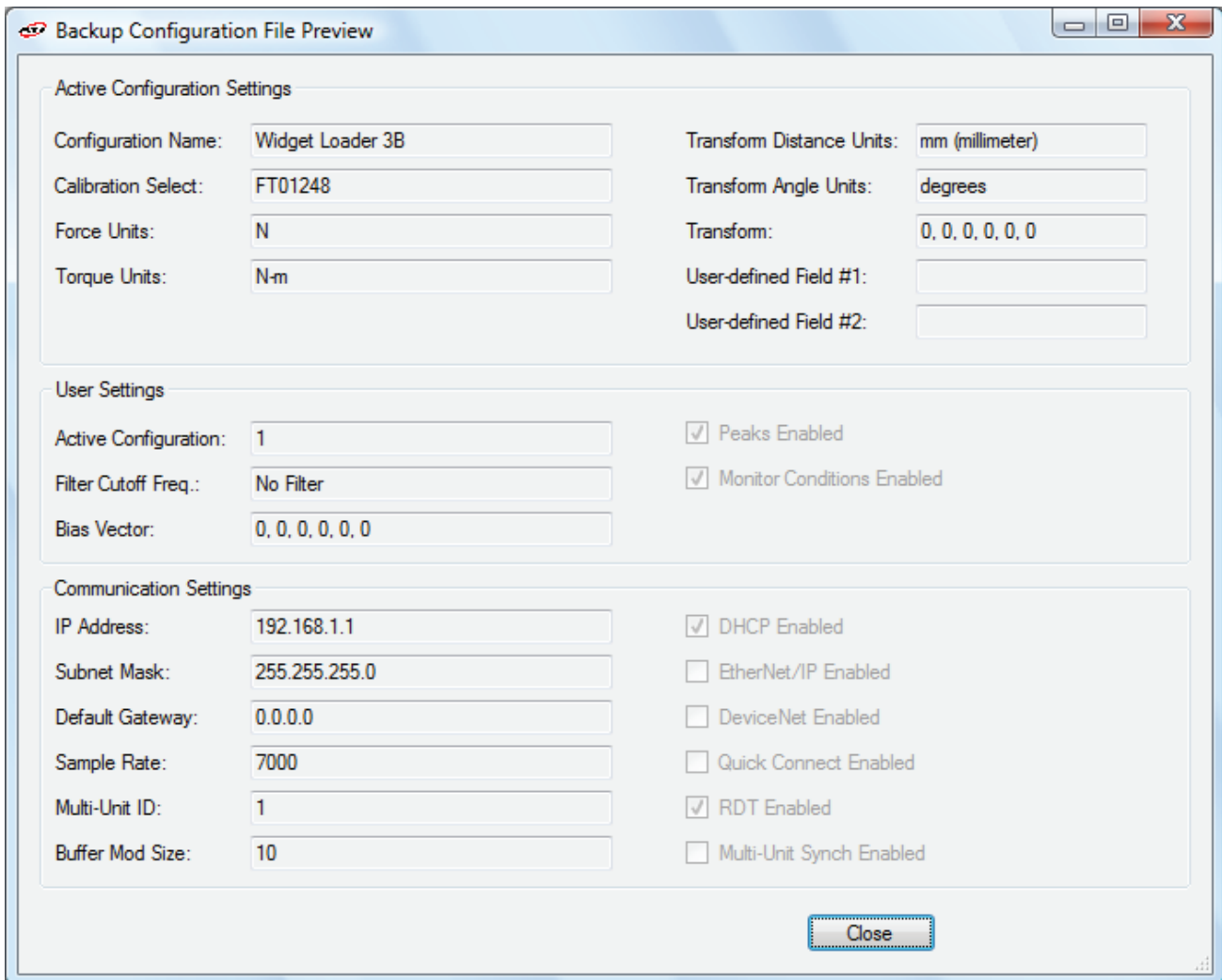

## 7. Common Gateway Interface (CGI)

The Net F/T can be configured over Ethernet using the standard HTTP get method which sends configuration variables and their values in the requested URL.

Each variable is only settable from the *CGI* page which is responsible for that variable. Each *CGI* page and associated settable variables are listed in tables within the following section.

URLs are constructed using the following syntax:

```
http://<netFTAddress>/<CGIPage.cgi>?<firstVariableAssignment>&<nextVariable Assignment>
```

where:

http://	indicates an HTTP request
<netFTAddress>	is the Ethernet address of the Net F/T system
/	a separator
<CGIPage.cgi>	the name of the <i>CGI</i> page that holds the variables to be accessed
?	a separator marking the start of variable assignments
<firstVariableAssignment>	a variable assignment using the format described below
&<nextVariableAssignment>	a variable assignment using the format described below, but the variable name is preceded by an ampersand. This variable assignment is optional and may be repeated for multiple variables.

Variables are assigned new values using the syntax:

```
variableName=newValue
```

where:

variableName	is the name of the variable to be assigned
=	indicates assignment
newValue	is the value to be assigned to the variable. Text for text variables should not be enclosed in quotes. To include the ampersand character in text for a text variable use %26. Floating point numbers are limited to twenty characters.

Example:

```
http://192.168.1.1/setting.cgi?setcfgsel=2&setuserfilter=0&setpke=1
```

tells the Net F/T at IP address 192.168.1.1 to set CGI variables *setcfgsel* to 2, *setuserfilter* to 0, and *setpke* to 1.

The maximum length of these URLs may be determined by a number of factors external to the Net F/T. Exceeding the maximum length may result in an error or variables being incorrectly set.



## 7.1 Settings CGI (setting.cgi)

This CGI allows the user to specify certain global settings such as Low-Pass Filter selection, Peak Monitoring Enable, Software Bias Vector, and Active Configuration selection. For related information, see [Section 4.4—Settings Web Page \(setting.htm\)](#).

Variable Name	Allowed Values	Description					
setcfgsel	integers: 0 to 15	Sets the active configuration. Note that the value used by <i>setcfgsel</i> is one less than the configuration numbers displayed on the web pages.					
setuserfilter	integers: 0 to 12	Sets the cutoff frequency of the low-pass filtering as follows:					
		<b>Value</b>	<b>Cutoff</b>	<b>Value</b>	<b>Cutoff</b>	<b>Value</b>	<b>Cutoff</b>
		0	no filter	5	35 Hz	10	2000 Hz
		1	838 Hz	6	18 Hz	11	2500 Hz
		2	326 Hz	7	8 Hz	12	3000 Hz
		3	152 Hz	8	5 Hz		
4	73 Hz	9	1500 Hz				
setpke	integers: 0 or 1	Enable (value = 1) or disable (value = 0) peak logging					
setbias <i>n</i>	integers: -32768 to 32767	Sets the offset value for strain gage <i>n</i> . For example, <i>setbias3=0</i> would zero the bias of the fourth strain gage (Strain gages are enumerated starting at zero.)					

## 7.2 Monitor Conditions CGI (moncon.cgi)

This CGI defines and controls Monitor Conditions statements. Monitor Conditions statements can be turned off or on and need to have an axis, a comparison type, a comparison counts value, and an output code defined.

Variable Name	Allowed Values	Description		
setmce	Integers: 0 or 1	Enable (value = 1) or disable (value = 0) all Condition statement processing.		
mce <i>n</i>	Integers: 0 or 1	Enable (value = 1) or disable (value = 0) Condition statement <i>n</i> .		
mcx <i>n</i>	Integers: -1 to 5	Selects the axis evaluated by Condition statement <i>n</i> .		
		Value	Description	Menu Value
		-1	Statement disabled	blank
		0	Fx axis	Fx
		1	Fy axis	Fy
		2	Fz axis	Fz
		3	Tx axis	Tx
		4	Ty axis	Ty
5	Tz axis	Tz		
mcv <i>n</i>	Integers: -2147483648 to +2147483647	Sets the counts value to compare the current axis value by Condition statement <i>n</i> .		
mcon	Hexadecimal: 0x00 to 0xFF	Sets the output code for Condition statement <i>n</i> .		
where <i>n</i> is an integer ranging from 0 to 15 representing the Condition statement index				

## 7.3 Configurations CGI (config.cgi)

Use this CGI to specify the output parameters of the sensor system. Any of the sixteen configurations can be defined. Changing configurations allows selection of the transducer calibration to use and what tool transformations to apply to that calibration.

When using config.cgi the cgid value specifies which configuration is targeted. For example, <http://<netFTAddress>/config.cgi?cgid=3&cfgnam=test123> sets the name of the fourth configuration (which is at index 3) to test123.

For related information, refer to [Section 4.6—Configurations Web Page \(config.htm\)](#).

Table 7.3—config.cgi Variables				
Variable Name	Allowed Values	Description		
cfgid	integers: 0 to 15	Zero-based index of the configuration to be set during this CGI call. This variable is required for all calls to config.cgi.		
cfgnam	Text string of up to 32 characters	Sets the configuration name.		
cfgcalsel	integers: 0 to 15	Sets the calibration used by the configuration.		
cfgfu	Integers: 1 to 6	Sets the force units used by the configuration. This value determines the <i>Counts per Force</i> and <i>Max Ratings</i> values on the config.htm user web page.		
		Value	Description	Menu Value
		1	Pound-force	lbf
		2	Newtons	N
		3	Kilopound-force	klbf
		4	Kilonewton	kN
		5	Kilogram-force	kgf
6	Gram-force	gf		
cfgtu	Integers: 1 to 6	The torque units used by the configuration. This value determines the <i>Counts per Torque</i> and <i>Max Ratings</i> values on the config.htm user web page.		
		Value	Description	Menu Value
		1	Pound-force-inch	lbf-in
		2	Pound-force-feet	lbf-ft
		3	Newton-meter	Nm
		4	Newton-millimeter	Nmm
		5	Kilogram-force-centimeter	kgf-cm
6	Kilonewton-meter	kNm		
cfgtdu	Integers: 1 to 5	The distance measurement units used by the configuration's tool transformation.		
		Value	Description	Menu Value
		1	inch	in
		2	foot	ft
		3	millimeter	mm
		4	centimeter	cm
5	meter	m		
cfgtau	Integers: 1 or 2	The rotation units used by the configuration's tool transformation.		
		Value	Description	Menu Value
		1	degrees (°)	degrees
2	radians	radians		
cfgtfx0	Floating point	Sets the tool transformation distance Dx. Distance must be in <i>cfgtdu</i> distance units.		
cfgtfx1	Floating point	Sets the tool transformation distance Dy. Distance must be in <i>cfgtdu</i> distance units.		

**Table 7.3—config.cgi Variables**

Variable Name	Allowed Values	Description
cfgtfx2	Floating point	Sets the tool transformation distance Dz. Distance must be in <i>cfgtdu</i> distance units.
cfgtfx3	Floating point	Sets the tool transformation rotation Rx. Rotation must be in <i>cfgtau</i> angular units.
cfgtfx4	Floating point	Sets the tool transformation rotation Ry. Rotation must be in <i>cfgtau</i> angular units.
cfgtfx5	Floating point	Sets the tool transformation rotation Rz. Rotation must be in <i>cfgtau</i> angular units.
cfgusra	Text string of up to 16 characters	Stores text in user-defined field #1.
cfgusrb	Text string of up to 16 characters	Stores text in user-defined field #2.

## 7.4 Communications CGI (comm.cgi)

This CGI sets the networking options of the Net Box. For more information on the parameters, refer to [Section 4.7—Communication Settings Page \(comm.htm\)](#).

Table 7.4—comm.cgi Variables			
Variable Name	Allowed Values	Description	
comnetdhcp	Integers: 0 or 1	Sets DHCP behavior.	
		<b>Value</b>	<b>Description</b>
		0	Use DHCP if available on network
		1	Use software-defined static IP values
comnetip	Any IPV4 address in dot-decimal notation	Sets the static IP address to be used when DHCP is disabled.	
comnetmsk	Any IPV4 subnet mask in dot-decimal notation	Sets the subnet mask to be used when DHCP is disabled.	
comnetgw	Any IPV4 address in dot-decimal notation	Sets the gateway to be used when DHCP is disabled.	
comeipe	Integers: 0 or 1	Enable (value = 1) or disable (value = 0) EtherNet/IP protocol. Basic CAN protocol must be selected when EtherNet/IP protocol is enabled.	
mcxn	Integers: -1 to 5	Selects CAN bus protocol.	
		<b>Value</b>	<b>Description</b>
		0	Basic CAN protocol
		1	DeviceNet compatibility-mode protocol
		EtherNet/IP protocol must be disabled when DeviceNet protocol is selected.	
comrdte	Integers: 0 or 1	Enable (value = 1) or disable (value = 0) RDT interface.	
comrdtrate	1 to 7000	Sets the RDT output rate in Hertz. The actual value used may be rounded up; see <a href="#">Section 4.7—Communication Settings Page (comm.htm)</a> for details.	
comrdtbsiz	Integers: 1 to 40	RDT Buffer Mode buffer size.	

## 8. System Settings XML Pages

The Net F/T's current settings can be retrieved in XML format using standard Ethernet HTTP requests and enables programs to read system settings such as the Counts per Force value. The Net F/T's Java demo application uses data provided in these *XML* pages to correctly scale displayed data.

In the following tables, the data types of XML elements are as follows:

Table 8.1—Types Used by XML Elements	
Data Type	Description
DINT	Signed double integer (32 bit)
ENABL	Boolean using <i>Enabled</i> to represent 1 and <i>Disabled</i> to represent 0
HEX $n$	Hexadecimal number of $n$ bits, prefixed with <i>0x</i> .
INT	Signed integer (16 bit)
REAL	Floating-point number (32 bit)
SINT	Signed short integer (8 bit)
STRING $n$	String of $n$ characters
UDINT	Unsigned double integer (32 bit)
UINT	Unsigned integer (16 bit)
USINT	Unsigned short integer (8 bit)

The values of all data types are presented as an ASCII strings.

Arrays are represented if the suffix  $[i]$  is attached to the data type, where  $i$  indicates the number of values in the array. Array values in an XML element may be separated by a semicolon, comma, or space.

### 8.1 System and Configuration Information (netftapi2.xml)

The XML page netftapi2.xml retrieves the system setup and active configuration. To retrieve information about other configurations, those configurations must be made active prior to the request.

A configuration index can be specified when requesting this configuration information. This is done by appending  $?index=n$  to the request, where  $n$  is the index of the desired configuration. If a configuration index is not specified, the active configuration is assumed.

For example, to retrieve configuration information for the second configuration the requested page would be netftapi2.xml? $index=1$ .

The reference column in [Table 8.2](#) indicates which .htm page and .cgi function access this element. For related information, refer to the corresponding entry in [Section 4—Web Pages](#) or [Section 7—Common Gateway Interface \(CGI\)](#).

**Table 8.2—XML Elements in netftapi2.xml**

XML Element	Data Type	Description	Reference
runstat	HEX32	System status code	–
runft	DINT[6]	Force and torque values in counts	rundata
runpkmx	DINT[6]	Maximum peak values in counts	rundata
runpkmn	DINT[6]	Minimum peak values in counts	rundata
runsg	INT[6]	Strain gage values	rundata
runmcb	HEX32	Conditions breached	rundata
runmco	HEX8	Monitor Conditions Output	rundata
runmcl	USINT	Monitor Condition Latched	rundata
setcfgsel	USINT	Active configuration	setting
setuserfilter	USINT	Low-pass filter cutoff frequency menu selection	setting
setpke	USINT	Peak monitoring processing status	setting
setbias	DINT[6]	Software bias vector	setting
setmce	USINT	Condition processing status	moncon
mce	USINT[16]	Condition statements' individual enabling	moncon
mcx	USINT[16]	Condition statements' selected axes	moncon
mcc	USINT[16]	Condition statements' comparisons	moncon
mcv	DINT[16]	Condition statements' counts values for comparison	moncon
mco	HEX8[16]	Condition statements' output codes	moncon
cfgnam	STRING32	Name of active configuration	config
cfgcalsel	USINT	Calibration used by active configuration	config
cfgcalsn	STRING8	Serial number of active configuration's calibration	config
cfgfu	USINT	Force units used by active configuration	config
scfgfu	STRING8	Name of force units used by active configuration	config
cfgtu	USINT	Torque units used by active configuration	config
scfgtu	STRING8	Name of torque units used by active configuration	config
cfgcpf	DINT	Counts per force as determined by the active configuration settings	config
cfgcpt	DINT	Counts per torque as determined by the active configuration settings	config
cfgmr	REAL[6]	Calibrated sensing ranges in units as determined by the active configuration settings	config
cfgtdu	USINT	Tool transformation distance units used by active configuration	config
scfgtdu	STRING16	Name of tool transformation distance units used by active configuration	config
cfgtau	USINT	Tool transformation rotation units used by active configuration	config
scfgtau	STRING8	Name of tool transformation rotation units used by active configuration	config
cfgtfx	REAL[6]	Tool transformation distances and rotations applied by active configuration	config
cfgusra	STRING16	User-defined field #1 for the active configuration	config
cfgusrb	STRING16	User-defined field #2 for the active configuration	config
comnetdhcp	ENABL	DHCP behavior setting	comm



**Table 8.2—XML Elements in netftapi2.xml**

XML Element	Data Type	Description	Reference	
comnetip	STRING15	Static IP address	comm	
comnetmsk	STRING15	Static IP subnet mask	comm	
comnetgw	STRING15	Static IP gateway	comm	
comeipe	ENABL	EtherNet/IP protocol setting	comm	
nethwaddr	STRING17	Ethernet MAC Address	comm	
comdnte	ENABL	CAN bus protocol setting	comm	
comdntmac	USINT	DeviceNet MAC ID	comm	
comdntbaud	USINT	CAN network baud rate:	comm	
		<b>Value</b>		<b>Baud Rate</b>
		0		125 kHz
		1		250 kHz
		2		500 kHz
3	SoftSet			
comrdte	ENABL	RDT interface setting	comm	
comrdtrate	UDINT	RDT output rate	comm	
comrdtbsiz	USINT	RDT Buffer Mode buffer size	comm	
mfgdighwa	STRING17	Ethernet MAC Address	manuf	
mfgdignsn	STRING8	Digital board serial number	manuf	
mfgdigver	STRING8	Digital board firmware revision	manuf	
mfgdigrev	STRING8	Digital board hardware revision	manuf	
mfganasn	STRING8	Analog board serial number	manuf	
mfganarev	STRING8	Analog board hardware revision	manuf	
mfgtxdmdl	STRING16	Analog board location	manuf	
netip	STRING15	IP address in use	–	
runrate	UDINT	Internal sample rate for strain gage collection	–	

## 8.2 Calibration Information (netftcalapi.xml)

The XML page netftcalapi.xml retrieves information about a specific calibration. Retrieved calibration information has not been modified by any of the Net F/T's configuration settings.

A calibration index can be specified when requesting this calibration information. Specify the index by appending *?index=n* to the request, where n is the index of the desired calibration. If a calibration index is not specified, the currently-used calibration is assumed.

For example, to retrieve calibration information for the third calibration the requested page would be *netftcalapi.xml?index=2*.

Table 8.3—XML Elements in netftcalapi.xml		
XML Element	Data Type	Calibration Information
calsn	STRING8	Serial number
calpn	STRING32	Calibration type
caldt	STRING20	Calibration date
calfu	USINT	Force units (refer to config.cgi variable cfgfu for values)
scalfu	STRING8	Name of force units
caltu	USINT	Torque units used (refer to config.cgi variable cfgtu for values)
scaltu	STRING8	Name of torque units
calmr	REAL[6]	Calibrated sensing ranges in calfu and caltu units
calcpf	DINT	Counts per force unit
calcpt	DINT	Counts per torque unit
calsf	DINT[6]	Scaling factor for DeviceNet and CAN
calusra	STRING16	Calibration note field #1
calusrb	STRING16	Calibration note field #2

## 9. UDP Interface Using RDT

The Net F/T can output data at up to 7000 Hz over Ethernet using UDP. This method of fast data collection is called Raw Data Transfer (RDT). If the overhead of DeviceNet or EtherNet/IP is too much for an application, or if extra speed is required in data acquisition, RDT provides an easy method to obtain the forces, torques, and status codes of the Net F/T system.

**NOTICE:** Multi-byte values must be transferred to the network high byte first and with the correct number of bytes. Some compilers align structures to large field sizes, such as 32- or 64-bit fields, and send an incorrect number of bytes. C compilers usually provide the functions *htons()*, *htonl()*, *ntohs()*, and *ntohl()* that can automatically handle these issues.

### 9.1 RDT Protocol

There are six commands in the RDT protocol and are listed in [Table 9.1](#). Any command received by the Net F/T takes precedence over any previously-received commands.

Table 9.1—RDT Commands		
Command	Command Name	Command Response
0x0000	Stop streaming	none
0x0002	Start high-speed real-time streaming	RDT record(s)
0x0003	Start high-speed buffered streaming	RDT record(s)
0x0041	Reset Condition Latch	none
0x0042	Set Software Bias	none

The streaming modes are further described in [Table 9.2](#).

Table 9.2—Streaming Modes			
Mode	Command	Speed	Situation Best Suited To:
0x0002	Start high-speed real-time streaming	Fast (up to 7000 Hz)	Real-time response applications.
0x0003	Start high-speed buffered streaming	Fast (up to 7000 Hz), but comes in bursts (buffers)	Collecting data at high speed, but not responding to it in real-time. Buffer size is set on the <i>Communication Settings</i> web page. See <a href="#">Section 4.7—Communication Settings Page (comm.htm)</a> .

To start the Net F/T outputting RDT messages, first send an RDT request to it. The Net F/T listens for RDT requests on UDP port 49152. It also sends the RDT output messages from this port.



**CAUTION:** A dedicated Ethernet network should be used for the streaming of Net F/T data. Net F/T RDT streaming modes can send large amounts of data to the Ethernet connection which can disrupt other communications on the network. See [Section 16.1—Improving Ethernet Throughput](#).



**CAUTION:** To reduce the possibility of network problems, especially when on a shared network, Net F/T RDT streaming modes should only be used at high output rate when absolutely necessary.

**NOTICE:** All Net F/T RDT streaming modes continue to stream until a Stop Streaming command (0x0000) is received. If the client that requested the data is removed from the network (disconnected, powered down, out of wireless range, etc.) before it sends a Stop Streaming command, the Net F/T will continue to stream data to the network even though there is no recipient.

All RDT requests use the following RDT request structure:

```
{  
    Uint16 command_header = 0x1234;    // Required  
    Uint16 command;                    // Command to execute  
    Uint32 sample_count;                // Samples to output (0 = infinite)  
}
```

Set the command field of the RDT request to the command from [Table 9.1](#). Set sample\_count to the number of samples to output. If the sample\_count is set to zero, the Net Box continuously outputs until the user sends a RDT request with command set to zero.

RDT records sent in request to an RDT request have this structure:

```
{  
    Uint32 rdt_sequence; // RDT sequence number of this packet.  
    Uint32 ft_sequence;  // The record's internal sequence number  
    Uint32 status;       // System status code  
  
    // Force and torque readings use counts values  
    Int32 Fx;           // X-axis force  
    Int32 Fy;           // Y-axis force  
    Int32 Fz;           // Z-axis force  
    Int32 Tx;           // X-axis torque  
    Int32 Ty;           // Y-axis torque  
    Int32 Tz;           // Z-axis torque  
}
```

- rdt\_sequence:** The position of the RDT record within a single output stream. The RDT sequence number is useful for determining if any records were lost in transit. For example, in a request for 1000 records, rdt\_sequence will start at 1 and run to 1000. The RDT sequence counter will roll over to zero for the increment following 4294967295 ( $2^{32}-1$ ).
- ft\_sequence:** The internal sample number of the F/T record contained in this RDT record. The F/T sequence number starts at 0 when the Net F/T is powered up and increments at the internal sample rate (7000 per sec). Unlike the RDT sequence number, ft\_sequence does not reset to zero when an RDT request is received. The F/T sequence counter will roll over to zero for the increment following 4294967295 ( $2^{32}-1$ ).
- status:** Contains the system status code at the time of the record.
- Fx, Fy, Fz, Tx, Ty, Tz:** The F/T data as counts values.

If using buffered mode, then the number of RDT records received in a UDP packet is equal to the RDT buffer size displayed on the *Communications* web page. For a description of RDT Buffer Size, see [Section 4.7—Communication Settings Page \(comm.htm\)](#).

## 9.2 Extended RDT Requests

Extended RDT requests have the following structure:

```
{  
uint16 hdr;           /* Always set to 0x1234 */  
uint16 cmd;          /* The command code, with high bit set to '1'. */  
uint32 count;        /* The number of samples to send in response. */  
uint32 ipaddr_dest;  /* The ip address to send the response to. */  
uint16 port_dest;    /* The port to send the response to. */  
}
```

The extended RDT request format is used when the Net F/T should send the UDP F/T data to a different IP address than the IP address from which the request comes. This is useful, for example, if the Net F/T stream data is sent to a multicast address so that multiple clients can receive the stream at once.

The command codes used in the Extended RDT format are the same as the command codes in normal RDT requests, except that the high bit is set to a '1'. For example, the command code 2, for high-speed streaming, is changed to 0x8002 for use with the Extended RDT request packet structure.

For example, to request high speed streaming to the multicast address 224.0.5.128, port 28250, send a UDP packet with the following data:

```
{ 0x12, 0x34, 0x80, 0x02, 0x00, 0x00, 0x00, 0x00, 224, 0, 5, 128, 0x6e, 0x5a };
```

Clients can then subscribe to the UDP multicast IP address 224.0.5.128, and receive the streaming data on port 28250. Users should consult their client system's documentation for information on how to subscribe to a multicast IP address.

## 9.3 Calculating F/T Values for RDT

To obtain the real force and torque values, each force output value has to be divided by the Counts per Force and each torque output value has to be divided by the Counts per Torque factor. The Counts per Force and Counts per Torque factors can be obtained from netftapi2.xml page. See cfcgpf and cfcgpt in [Section 8.1—System and Configuration Information \(netftapi2.xml\)](#).

## 9.4 Multiple Clients

The RDT protocol is designed to respond to one client only. If a second client sends a command, the Net F/T will respond to the new client. Multiple clients could repeatedly request single packets, minimizing problems (the Java demo operates in this manner).

## 9.5 Notes on UDP and RDT Mode

RDT communications use UDP, with its minimal overhead, to maximize throughput. Unlike TCP, UDP does not check if a package was actually received.

In some Ethernet network configurations this can lead to the loss of RDT data sets. By checking the RDT sequence number of each set, it can be determined if a data set was lost. The RDT sequence number of each data set sent is one greater than the last data set sent for that RDT request. If a received data set's RDT sequence number is not one greater than the last received data set, then a loss of data has occurred (the program must also account for rollover of the RDT sequence number).

The likelihood of data loss highly depends on the Ethernet network configuration, and there are ways to reduce the probability of data loss to almost zero. For details, refer to [Section 16.1—Improving Ethernet Throughput](#).

The maximum data latency, measured from the beginning of data acquisition to when the last data bit is sent to the Ethernet network, is less than 28  $\mu$ s.

The Net F/T only supports one UDP connection at a time.

## 9.6 Example Code

Example C code can be found on the ATI website at [http://www.ati-ia.com/Products/ft/software/net\\_ft\\_software.aspx](http://www.ati-ia.com/Products/ft/software/net_ft_software.aspx).

# 10. TCP Interface

## 10.1 General

The TCP interface listens on TCP port 49151. All commands are 20 bytes in length. All responses begin with the two byte header 0x12, 0x34.

## 10.2 Command Codes

```
READFT           = 0,      /* Read F/T values. */
READCALINFO     = 1,      /* Read calibration info. */
WRITETTRANSFORM = 2,      /* Write tool transformation. */
WRITECondition  = 3,      /* Write monitor condition. */
```

## 10.3 Read F/T Command

```
{
uint8          command;      /* Must be READFT (0) . */
uint8          reserved[15]; /* Should be all 0s. */
uint16         MCEnable;     /* Bitmap of MCs to enable. */
uint16         sysCommands;  /* Bitmap of system commands. */
}
```

Each bit position 0-15 in MCEnable corresponds to the monitor condition at that index. If the bit is a '1', that monitor condition is enabled. If the bit is a '0', that monitor condition is disabled.

Bit 0 of sysCommands controls the Bias. If bit 0 is a '1', the system is biased. If bit 0 is a '0', no action is taken.

Bit 1 of sysCommands controls the monitor condition latch. If bit 1 is a '1', the monitor condition latch is cleared, and monitor condition evaluation begins again. If bit 1 is a '0', no action is taken.

## 10.4 Read F/T Response

```
{  
  uint16 header;      /* always 0x1234. */  
  uint16 status;     /* Upper 16 bits of status code. */  
  int16 ForceX;      /* 16-bit Force X counts. */  
  int16 ForceY;      /* 16-bit Force Y counts. */  
  int16 ForceZ;      /* 16-bit Force Z counts. */  
  int16 TorqueX;     /* 16-bit Torque X counts. */  
  int16 TorqueY;     /* 16-bit Torque Y counts. */  
  int16 TorqueZ;     /* 16-bit Torque Z counts. */  
}
```

The status code is the upper 16 bits of the 32-bit status code.

The force and torque values in the response are equal to (actual ft value  $\times$  calibration counts per unit  $\div$  16-bit scaling factor). The counts per unit and scaling factor are read using the read calibration information command.

## 10.5 Read Calibration Info Command

```
{  
  uint8 command;      /* Must be READCALINFO (1). */  
  uint8 reserved[19]; /* Should be all 0s. */  
}
```



## 10.6 Read Calibration Info Response

```
{  
    uint16 header;          /* always 0x1234. */  
    uint8 forceUnits;      /* Force Units. */  
    uint8 torqueUnits;     /* Torque Units. */  
    uint32 countsPerForce; /* Calibration Counts per force unit. */  
    uint32 countsPerTorque; /* Calibration Counts per torque unit. */  
    uint16 scaleFactors[6]; /* Further scaling for 16-bit counts. */  
}
```

The status code is the upper 16 bits of the 32-bit status code.

The force and torque values in the response are equal to (actual ft value  $\times$  calibration counts per unit  $\div$  16-bit scaling factor). The counts per unit and scaling factor are read using the read calibration information command.

The force unit codes are:

- 1: Pound
- 2: Newton
- 3: Kilopound
- 4: Kilonewton
- 5: Kilogram
- 6: Gram

The torque unit codes are:

- 1: Pound-inch
- 2: Pound-foot
- 3: Newton-meter
- 4: Newton-millimeter
- 5: Kilogram-centimeter
- 6: Kilonewton-meter

## 10.7 Write Tool Transform Command

```
{  
    uint8 command; /* Must be WRITETRANSFORM (2). */  
    uint8 transformDistUnits; /* Units of dx,dy,dz */  
    uint8 transformAngleUnits; /* Units of rx,ry,rz */  
    int16 transform[6]; /* dx, dy, dz, rx, ry, rz */  
    uint8 reserved[5]; /* Should be all zeroes. */  
}
```

The 'transform' elements are multiplied by 100 to provide good granularity with integer numbers.

The distance unit codes are:

- 1: Inch
- 2: Foot
- 3: Millimeter
- 4: Centimeter
- 5: Meter

The angle unit codes are:

- 1: Degrees
- 2: Radians.

The response is a standard Write Response.

## 10.8 Write Monitor Condition Command

```
{  
    uint8 command;           /* Must be WRITECondition. */  
    uint8 index;            /* Index of monitor condition. 0-31. */  
    uint8 axis;             /* 0 = fx, 1 = fy, 2 = fz, 3 = tx, 4 = ty, 5 = tz. */  
    uint8 outputCode;       /* Output code of monitor condition. */  
    int8 comparison;        /* Comparison code. 1 for "greater than" (>), -1  
                             for "less than" (<). */  
    int16 compareValue;     /* Comparison value, divided by 16 bit  
                             Scaling factor. */  
}
```

## 10.9 Write Response

```
{  
    uint16 header;          /* Always 0x1234. */  
    uint8 commandEcho;     /* Echoes command. */  
    uint8 status;           /* 0 if successful, nonzero if not. */  
}
```

## 11. EtherNet/IP Operation

### 11.1 Overview

The Net F/T operates as a Server on the EtherNet/IP network and supports Class 3 Connected Explicit Messaging, UCMM Explicit Messaging, and Class 1 Connected Cyclic I/O Messaging. EtherNet/IP network supports one input-only connection and does not support a listen-only connection. The Net F/T does not support any Client functionality.

EtherNet/IP uses the CIP protocol described in [Section 11—EtherNet/IP Operation](#).

EtherNet/IP Protocol must be enabled on the *Communications* page to use EtherNet/IP (refer to [Section 4.7—Communication Settings Page \(comm.htm\)](#)).

Case	Instance	Size (bytes)	RT Transfer Format	Connection Type
Configuration	128	0	n/a	n/a
Input (Target to Originator)	100	28	Modeless	Point-to-Point
Output (Originator to Target) EtherNet/IP O2T Data Disabled	102	0	Modeless	Point-to-Point
Output (Originator to Target) EtherNet/IP O2T Data Enabled	102	4	Run/Idle	Point-to-Point

### 11.2 Module and Network Status LED

The module status LED is identified on the Net Box as MS. It provides device status for power and proper operation. The EtherNet/IP network status LED is identified on the Net Box as NS EN. For an outline of the LED operation, refer to [Figure 3.17](#) and [Table 3.4](#).

## 12. DeviceNet-Compatibility Mode Operation

### 12.1 Overview

The Net F/T operates as a Group 2-Only Server on the DeviceNet network and supports Explicit Messaging and Polled I/O messaging for the predefined Master/Slave Connection set. The Net F/T DeviceNet Node supports the Unconnected Message Manager (UCMM).

DeviceNet-compatibility mode uses the CIP protocol described in [Section 13—EtherNet/IP and DeviceNet CIP Model](#).

To use the Net F/T's DeviceNet-Compatibility Mode:

- DeviceNet must be selected on the *Communications* page (refer to [Section 4.7—Communication Settings Page \(comm.htm\)](#)).
- Power must be present on the Pwr/CAN connector.

### 12.2 MAC ID

The MAC ID is set by either hardware or software configuration to a value from 0 to 63. In order for the MAC ID to be set by software, DIP switch positions 1 through 8 must be ON. If the MAC ID is set by software, the baud rate must also be set by software. For more information, refer to [Section 3.9.2—Node Address](#) and [Table 3.2](#). The factory set MAC ID is 54.

### 12.3 Baud Rate

Baud Rate is set by either hardware or software configuration to 125 kbps, 250 kbps or 500 kbps. The baud rate will be set by software when DIP switch positions 7 and 8 are ON. For more information, refer to [Section 3.9.3—Baud Rate](#) and [Table 3.3](#). The factory set baud rate is 500 kbps.

### 12.4 Module and Network Status LED

The module status LED is identified on the Net Box as MS. It provides device status for power and proper operation. The DeviceNet network status LED is identified on the Net Box as NS DN. For an outline of the LED operation, refer to [Figure 3.17](#) and [Table 3.4](#).

### 12.5 EDS File

The DeviceNet Electronic Data Sheet (EDS) file for the system is in the \EDS directory and can be downloaded at: [https://www.ati-ia.com/Products/ft/software/net\\_ft\\_software.aspx](https://www.ati-ia.com/Products/ft/software/net_ft_software.aspx).

## 13. EtherNet/IP and DeviceNet CIP Model

### 13.1 Overview

The Net F/T operates as a Group 2-Only Server on the DeviceNet network. It supports Explicit Messaging and Polled I/O messaging for the predefined Master/Slave Connection set. The Net F/T DeviceNet Node does support the Unconnected Message Manager (UCMM).

The Net F/T operates as a Server on the EtherNet/IP network. It supports Class 3 Connected Explicit Messaging, UCMM Explicit Messaging and Class 1 Connected Cyclic I/O Messaging. The Net F/T does not support any Client functionality.

EtherNet/IP and DeviceNet protocols cannot be enabled at the same time.

Table 13.1—Name and Data Value	
Name	Data Value
Vendor Number	555
Device Type	0
Product Code Number	1
Product Name	ATI Industrial Automation F/T

Table 13.2—DeviceNet Input Bitmap	
WORD (16-bit)	Name
0	Status word, bits 16 through 31
1	Fx (16-bit)
2	Fy (16-bit)
3	Fz (16-bit)
4	Tx (16-bit)
5	Ty (16-bit)
6	Tz (16-bit)

Table 13.3—EtherNet/IP Input Bitmap	
DWORD (32-bit)	Name
0	Status word (32-bit)
1	Fx (32-bit)
2	Fy (32-bit)
3	Fz (32-bit)
4	Tx (32-bit)
5	Ty (32-bit)
6	Tz (32-bit)

There is no output data if the Ethernet/IP O2T Data option on the *Communications* page ([Section 4.7—Communication Settings Page \(comm.htm\)](#)) is disabled.

Table 13.4—Ethernet/IP Output Mapping			
Byte	BitNumber	Name	Description/Function
0	0	Bias	Perform tare function to zero out any load reading
	1	Reset Latch	Reset Condition latch
	2	reserved	reserved
	3	reserved	reserved
	4	reserved	reserved
	5	reserved	reserved
	6	reserved	reserved
	7	reserved	reserved
1	0	Config Select bit 0	Selects a Net F/T configuration, from 0 to 15
	1	Config Select bit 1	
	2	Config Select bit 2	
	3	Config Select bit 3	
	4	reserved	reserved
	5	reserved	reserved
	6	reserved	reserved
	7	reserved	reserved
2	0-7	Condition high	Condition enable mask, high byte
3	0-7	Condition low	Condition enable mask, low byte

## 13.2 Calculating F/T Values for CIP

### 13.2.1 EtherNet/IP

For 16-bit format: to obtain the real force and torque values, a “no load” value is reported as +32768 counts, a negative full-scale load is reported as approximately 0 counts, and a positive full-scale load is reported as approximately 65536 counts. Each received force value has to be divided by  $(Counts\ per\ Force \div Scaling\ Factor\ for\ DeviceNet\ and\ CAN)$  for the axis and each received torque value has to be divided by  $(Counts\ per\ Torque \div Scaling\ Factor\ for\ DeviceNet\ and\ CAN)$  for the axis.

**NOTICE:** Be sure to use the scaling factors from the appropriate configuration which is usually the active configuration.

For 32-bit format: to obtain the real force and torque values, each force output value has to be divided by the Counts per Force and each torque output value has to be divided by the Counts per Torque factor.

The Counts per Force and Counts per Torque factors can be obtained from the *Configurations* web page (refer to [Section 4.6—Configurations Web Page \(config.htm\)](#)).

### 13.2.2 DeviceNet

In order to reduce the amount of data transmitted over DeviceNet, the force and torque values are reduced to 16 bits using the Scaling Factor for DeviceNet and CAN values (see [Figure 13.1](#)) before they are transmitted.

To obtain the force and torque values in user units, each received force value has to be divided by  $(Counts\ per\ Force \div Scaling\ Factor\ for\ DeviceNet\ and\ CAN)$  for the axis and each received torque value has to be divided by  $(Counts\ per\ Torque \div Scaling\ Factor\ for\ DeviceNet\ and\ CAN)$  for the axis.

**NOTICE:** Be sure to use the scaling factors from the appropriate configuration which is usually the active configuration.

The Counts per Force, Counts per Torque, and Scaling Factor for DeviceNet and CAN factors can be found on *Configurations* web page (refer to [Section 4.6—Configurations Web Page \(config.htm\)](#)).

**Figure 13.1—Scaling Factors for DeviceNet and CAN (from the webpage)**

The screenshot shows a configuration page with the following sections:

- Calibration Select:** #1 - FT0000
- Calibration Type:** Identity
- Force Units:** N
- Torque Units:** Nm
- Counts per Force:** 1
- Counts per Torque:** 1
- Calibrated Sensing Range (Units):**

Fx	Fy	Fz	Tx	Ty	Tz
32768	32768	32768	32768	32768	32768
- Scaling Factor for DeviceNet and CAN:** (highlighted with a blue box)
 

Fx	Fy	Fz	Tx	Ty	Tz
1	1	1	1	1	1
- Tool Transform Distance Units:** in
- Tool Transform Angle Units:** degrees
- Tool Transform:**

Dx	Dy	Dz	Rx	Ry	Rz
0	0	0	0	0	0
- User-defined Field #1:** empty
- User-defined Field #2:** empty

Buttons: Apply, Cancel

Page footer: ATi Industrial Automation, 1031 Goodworth Dr., Apex, NC 27539 USA. Phone: +1 919-772-0115 | Fax: +1 919-772-8259. info@ati-ia.com | http://www.ati-ia.com/



## 13.3 Object Model

### 13.3.1 Data Types

A description of all of the data types used in the object model are in the following table:

Table 13.5—Data Types	
Data Type	Description
BOOL	Boolean
BYTE	Bit String (8-bit)
DINT	Signed Double Integer (32-bit)
DWORD	Bit String (32-bit)
INT	Signed Integer (16-bit)
REAL	Floating Point
SHORT_STRING	Character string (1 byte per character, 1 byte length indicator)
SINT	Signed Short Integer (8-bit)
STRING	Character String (1 byte per character)
UDINT	Unsigned Double Integer (32-bit)
UINT	Unsigned Integer (16-bit)
USINT	Unsigned Short Integer (8-bit)
WORD	Bit String (16-bit)

### 13.3.2 EtherNet/IP

To obtain the real force and torque values, each force output value has to be divided by the Counts per Force, and each torque output value has to be divided by the Counts per Torque factor.

Table 13.6—Name and Data Value				
Attribute ID	Name	Data Type	Default Data Value	Access Rule
1	Revision	UINT	N/A	Get
2	Max Instance	UINT	6	Get
3	Number of Instances	UINT	6	Get
100	Bias <sup>1</sup>	USINT	N/A	Set

Note:

1. Bias – any set to non-zero value will bias, a set to zero will unbiased the transducer readings.

Table 13.7—Instance Attributes (Instance 1–6) <sup>1</sup>				
Attribute ID	Name	Data Type	Default Data Value	Access Rule
1	Raw Gage Reading	INT	N/A	Get
2	Gage Bias	INT	N/A	Get/Set

Note:

1. Instances 1–6 correspond to Gages 0–5 respectively.

Table 13.8—Instance Attributes (Instance 1–6) <sup>1</sup>			
Service Codes	Implemented for		Service Name
	Class Level	Instance Level	
0x0E	Yes	Yes	Get_Attribute_Single
0x10	No	Yes	Set_Attribute_Single

Note:

1. Instances 1–6 correspond to Gages 0–5 respectively.

### 13.3.3 Transducer Force/Torque Object (0x65—6 Instances)

Table 13.9—Class Attributes (Instance 0)				
Attribute ID	Name	Data Type	Default Data Value	Access Rule
1	Revision	UINT	1	Get
2	Max Instance	UINT	6	Get
3	Number of Instances	UINT	6	Get

Table 13.10—Instance Attributes (Instance 1–6) <sup>1</sup>				
Attribute ID	Name	Data Type	Default Data Value	Access Rule
1 <sup>2</sup>	Resolved Axis Data (32-bit)	DINT	N/A	Get
2	Resolved Axis Data (16-bit) (for DeviceNet)	INT	N/A	Get
3	Minimum Peak	DINT	N/A	Get/Set <sup>3</sup>
4	Maximum Peak	DINT	N/A	Get/Set <sup>3</sup>

Note:

- Instances 1, 2, 3, 4, 5, 6 correspond to axis Fx, Fy, Fz, Tx, Ty, Tz respectively.
- If 16-bit unsigned data is enabled, the upper 16 bits always remain 0 and the lower 16-bits are the unsigned 16-bit F/T data.
- Any set attribute value will reset the specified peak value.

Table 13.11—Common Services			
Service Codes	Implemented for		Service Name
	Class Level	Instance Level	
0x0E	Yes	Yes	Get_Attribute_Single
0x10	No	Yes	Set_Attribute_Single

### 13.3.4 Transducer Force/Torque Object (0x65—6 Instances)

Table 13.12—Class Attributes (Instance 0)				
Attribute ID	Name	Data Type	Default Data Value	Access Rule
1	Revision	UINT	1	Get

Table 13.13—Instance Attributes (Instance 1–6)				
Attribute ID	Name	Data Type	Default Data Value	Access Rule
1	Conditions Breached	DWORD	N/A	Get
2	Monitor Conditions Output Result	BYTE	N/A	Get
3	Monitor Condition Latched	BOOL	N/A	Get/Set <sup>1</sup>

Notes:

- Monitor Condition Latched – any set attribute value will reset value to *FALSE*.

Table 13.14—Common Services			
Service Codes	Implemented for		Service Name
	Class Level	Instance Level	
0x0E	Yes	Yes	Get_Attribute_Single
0x10	No	Yes	Set_Attribute_Single

### 13.3.5 System Status Object (0x67—1 Instance)

Table 13.15—Class Attributes (Instance 0)				
Attribute ID	Name	Data Type	Default Data Value	Access Rule
1	Revision	UINT	1	Get

Table 13.16—Instance Attributes (Instance 1)				
Attribute ID	Name	Data Type	Default Data Value	Access Rule
1	Status Code (32-bit)	DWORD	N/A	Get
2	Status Code (16-bit) <sup>1</sup>	WORD	N/A	Get

Note:

1. This attribute is sized for DeviceNet.

Table 13.17—Common Services			
Service Codes	Implemented for:		Service Name
	Class Level	Instance Level	
0x0E	Yes	Yes	Get_Attribute_Single

### 13.3.6 Configurations Object (0x71—16 Instances)

Table 13.18—Instance Attributes (Instance 1–16)				
Attribute ID	Name	Data Type	Default Data Value	Access Rule
1	Configuration Name	SHORT_STRING[32]	N/A	Get/Set
2	Calibration Selection (0 to 15)	USINT	N/A	Get/Set
3	Calibration Selection's Calibration Type	SHORT_STRING[32]	N/A	Get
4	User Force Units <sup>1</sup>	BYTE	N/A	Get/Set
5	User Torque Units <sup>2</sup>	BYTE	N/A	Get/Set
6	User Transform – Dx	REAL	N/A	Get/Set
7	User Transform – Dy	REAL	N/A	Get/Set
8	User Transform – Dz	REAL	N/A	Get/Set
9	User Transform – Rx	REAL	N/A	Get/Set
10	User Transform – Ry	REAL	N/A	Get/Set
11	User Transform – Rz	REAL	N/A	Get/Set
12	User Transform Distance Units <sup>3</sup>	BYTE	N/A	Get/Set
13	User Transform Angle Units <sup>4</sup>	BYTE	N/A	Get/Set
14	User Counts per Unit Force	UINT	N/A	Get
15	User Counts per Unit Torque	UINT	N/A	Get
16	User Max Rating – Fx	REAL	N/A	Get
17	User Max Rating – Fy	REAL	N/A	Get
18	User Max Rating – Fz	REAL	N/A	Get

Notes:

1. Refer to `cfgfu` in [Section 7.3—Configurations CGI \(config.cgi\)](#) for force units.
2. Refer to `cfgtu` in [Section 7.3—Configurations CGI \(config.cgi\)](#) for torque units.
3. Refer to `cfgtdu` in [Section 7.3—Configurations CGI \(config.cgi\)](#) for tool transformation distance units.
4. Refer to `cfgtau` in [Section 7.3—Configurations CGI \(config.cgi\)](#) for tool transformation angle units.

Table 13.18—Instance Attributes (Instance 1–16)				
Attribute ID	Name	Data Type	Default Data Value	Access Rule
19	User Max Rating – Tx	REAL	N/A	Get
20	User Max Rating – Ty	REAL	N/A	Get
21	User Max Rating – Tz	REAL	N/A	Get
100	User Defined Field #1	SHORT_STRING[16]	N/A	Get/Set
101	User Defined Field #2	SHORT_STRING[16]	N/A	Get/Set

Notes:

1. Refer to ckgfu in [Section 7.3—Configurations CGI \(config.cgi\)](#) for force units.
2. Refer to ckgtu in [Section 7.3—Configurations CGI \(config.cgi\)](#) for torque units.
3. Refer to ckgtdu in [Section 7.3—Configurations CGI \(config.cgi\)](#) for tool transformation distance units.
4. Refer to ckgtau in [Section 7.3—Configurations CGI \(config.cgi\)](#) for tool transformation angle units.

Table 13.19—Common Services			
Service Codes	Implemented for		Service Name
	Class Level	Instance Level	
0x0E	Yes	Yes	Get_Attribute_Single
0x10	No	Yes	Set_Attribute_Single

### 13.3.7 Transducer Force/Torque Object (0x65—6 Instances)

Table 13.20—Class Attributes (Instance 0)				
Attribute ID	Name	Data Type	Default Data Value	Access Rule
1	Revision	UINT	1	Get

Table 13.21—Instance Attributes (Instance 1–6)				
Attribute ID	Name	Data Type	Default Data Value	Access Rule
1	Conditions Breached	DWORD	N/A	Get
2	Monitor Conditions Output Result	BYTE	N/A	Get
3	Monitor Condition Latched	BOOL	N/A	Get/Set

Table 13.22—Common Services			
Service Codes	Implemented for:		Service Name
	Class Level	Instance Level	
0x0E	Yes	Yes	Get_Attribute_Single
0x10	No	Yes	Set_Attribute_Single

### 13.3.8 Monitor Conditions Settings Object (0x73—32 Instances)

Table 13.23—Class Attributes (Instance 0)				
Attribute ID	Name	Data Type	Default Data Value	Access Rule
1	Revision	UINT	1	Get
2	Max Instance	UINT	32	Get
3	Number of Instances	UINT	32	Get

Table 13.24—Instance Attributes (Instance 1–32)				
Attribute ID	Name	Data Type	Default Data Value	Access Rule
1	Enable/Disable	BOOL	N/A	Get/Set
2	Axis Number <sup>1</sup>	SINT	N/A	Get/Set
3	Comparison <sup>2</sup>	SINT	N/A	Get/Set
4	Counts Value	DINT	N/A	Get/Set
5	Output Code	BYTE	N/A	Get/Set

Note:

1. Refer to mcxn in [Section 7.2—Monitor Conditions CGI \(moncon.cgi\)](#) for axis information.
2. Refer to mccn in [Section 7.2—Monitor Conditions CGI \(moncon.cgi\)](#) for comparison information.

Table 13.25—Common Services			
Service Codes	Implemented for		Service Name
	Class Level	Instance Level	
0x0E	Yes	Yes	Get_Attribute_Single
0x10	No	Yes	Set_Attribute_Single

## 14. CAN Bus Operation

### 14.1 Overview

The Net F/T supports a basic CAN protocol to allow reading of force/torque data and system status word over CAN without the need for a DeviceNet scanner.

The CAN Bus base address and Baud Rate settings are configured using the DIP switches. For additional information, refer to [Section 3.9—DIP Switches and Termination Resistor](#).

To use the Net F/T's CAN bus protocol, CAN Bus must be selected on the *Communications* page (refer to [Section 4.7—Communication Settings Page \(comm.htm\)](#)) and power must be present on the Pwr/CAN connector.

### 14.2 Protocol Description

A request data message sent to the Net F/T initiates copying of the current set of F/T data into an output buffer and the subsequent transmission of the output buffer.

Depending on the request message identifier (REQUEST LONG or REQUEST SHORT), the Net F/T either sends 32-bit values packed into four messages or 16-bit values packed into two messages.

Values are in little endian format (least-significant byte first). For example, a 16-bit value received as 0x56 0x02 represents 0x0256. Signed numbers use 2's complement format. The 32-bit value received as 0x0F 0xCF 0xDA 0xDA 0xFD represents 0xFDDACF0F, which is a negative number (because the highest bit is set). Its decimal value is -35991793.

If a data request message is received during an ongoing transmission, the ongoing transmission is terminated, and the new request is processed.

### 14.3 Base Address and Communication Format

The CAN Bus base address is set by DIP switches 1 through 6. For more information refer to [Section 3.9.2—Node Address](#) and [Table 3.1](#). The factory set base address is 432.

Message to Net F/T	Response from Net F/T	CAN Identifier	Data length in bytes	1st–4th data bytes	5th–8th data bytes	Description
Request Long Data	-	Base Address	1	0x01 (BYTE)	N/A	Sends a copy of force and torque data in long format (an ongoing transmission will be terminated)
-	Fx and Tx data	Base Address +1	8	Fx value (DINT)	Tx value (DINT)	X-axis force and torque values in long format
-	Fy and Ty data	Base Address +2	8	Fy value (DINT)	Ty value (DINT)	Y-axis force and torque values in long format.
-	Fz and Tz data	Base Address +3	8	Fz value (DINT)	Tz value (DINT)	Z-axis force and torque values in long format.
-	Status and sample number	Base Address +4	8	system status (DINT)	sample number (DINT)	System status word and sample number in long format.

Table 14.2—Request Short Data						
Message to Net F/T	Response from Net F/T	CAN Identifier	Data length in bytes	1st–4th data bytes	5th–8th data bytes	Description
Request Long Data	-	Base Address	1	0x02 (BYTE)	N/A	Sends a copy of force and torque data in short format (an ongoing transmission is terminated)
-	Fx, Tx, Fy, and Tx data	Base Address +5	8	Fx value (INT) Tx value (INT)	Fy value (INT) Ty value (INT)	X-axis force and torque values and Y-axis force and torque in short format
-	Fz and Tz data, Status, and sample number	Base Address +6	8	Fz value (INT) Tz value (INT)	system status (INT) sample number (INT)	Z-axis force and torque values, system status word, and sample in short format.

Table 14.3—Bias Command						
Message to Net F/T	Response from Net F/T	CAN Identifier	Data length in bytes	1st–4th data bytes	5th–8th data bytes	Description
Bias	-	Base Address	1	0x04 (BYTE)	N/A	Zeros the force and torque readings at the current loading level.

Table 14.4—Clear Condition Latch Command						
Message to Net F/T	Response from Net F/T	CAN Identifier	Data length in bytes	1st–4th data bytes	5th–8th data bytes	Description
Clear Condition Latch	-	Base Address	1	0x08 (BYTE)	N/A	Clears the Condition latch so it can respond to subsequent conditions.

## 14.4 Baud Rate

Baud Rate is set by either hardware or software configuration to 125 kbps, 250 kbps or 500 kbps. The baud rate is set by software when DIP switch positions 7 and 8 are ON. For more information refer to [Section 3.9.3—Baud Rate](#) and [Table 3.3](#). The factory set baud rate is 500 kbps.

## 14.5 Calculating F/T Values for CAN

The Net F/T multiplies each F/T value with a factor before it is sent over the CAN interface. This calculation allows F/T values to be sent with the full resolution. The application program has to divide each F/T value with a specific factor to obtain the real data.

For 16-bit data handling and [Table 13.3](#) for 32-bit data handling, refer to [Table 13.2](#).



## 15. Fieldbus Operation

Operational information about the additional fieldbus included in some Net Boxes is described in the following sections.

### 15.1 PROFINET Fieldbus Interface

A Net Box with the -PN option provides a PROFINET interface for access to the F/T data and for control of certain functions. The standard EtherNet/IP and DeviceNet interfaces may be used simultaneously while using the PROFINET interface.

Although the Net Box's PROFINET interface shares the standard Ethernet port, it has its own MAC address and IP address. The fieldbus's MAC address is shown as MAC ID 2 on the connector side of the Net Box.

**NOTICE:** The PROFINET interface does not support DHCP. The Net Box's GSDML file details the PROFINET capabilities of the Net Box.

Unlike the Net F/T's other interfaces for tool transformations, the TCP interface uses scaled integer values to define distances and rotations.

The PROFINET interface parameters used in the -PN Net Box are listed in the following table:

Table 15.1—PROFINET Interface Parameters	
Parameter	Description
DCP	supported
Used Protocols (subset)	UDP, IP, ARP, ICMP (Ping)
Topology recognition	LLDP, SNMP V1, MIB2, physical device
VLAN- and priority tagging	yes
Context Management	by CL-RPC
Minimum cycle time	2ms
Minimum F/T data update rate	20Hz
Baud rate	100 MBit/s
Data transport layer	Ethernet II, IEEE 802.3

A GSDML file is available for the ATI website at:

[http://www.ati-ia.com/Products/ft/software/net\\_ft\\_software.aspx](http://www.ati-ia.com/Products/ft/software/net_ft_software.aspx) or can be requested via email at [ft.support@novanta.com](mailto:ft.support@novanta.com). For firmware versions before 2.2.59, the ATI Part Number for the GSDML file is 9031-05-1021. For firmware version 2.2.59 and later versions, the ATI Part Number for the GSDML file is 9031-05-1060.

### 15.1.1 Enabling the PROFINET Interface

The PROFINET fieldbus interface can be enabled and disabled using the *Communications* web page. For details, refer to the Fieldbus Module Settings portion of [Section 4.7—Communication Settings Page \(comm.htm\)](#).

Table 15.2—PROFINET Interface Parameters			
16-bit Word	Data Type	Name	Description/Function
0	INT	Status	Status word, bits 16 through 31
1	INT	Fx	Force in X-direction, 16-bit format
2	INT	Fy	Force in Y-direction, 16-bit format
3	INT	Fz	Force in Z-direction, 16-bit format
4	INT	Tx	Torque about X-axis, 16-bit format
5	INT	Ty	Torque about Y-axis, 16-bit format
6	INT	Tz	Torque about Z-axis, 16-bit format
7	UINT	Sequence	Incremented each time a dataset is sent

Input word 0, Status, contains bits 16 through 31 of the Net F/T's System Status Code (refer to [Section 17.1—System Status Code](#)).

Input words 1–6 contain values that represent F/T vectors Fx, Fy, Fz, Tx, Ty, and Tz. In order to reduce the amount of data transmitted over PROFINET, they are reduced to 16 bits using the Scaling Factor for DeviceNet and CAN values (see [Figure 13.1](#)) before they are transmitted.

To obtain the F/T values in user units, each received force value has to be divided by (Counts-per-Force ÷ Scaling Factor for DeviceNet and CAN) for the axis and each received torque value has to be divided by (Counts-per-Torque ÷ Scaling Factor for DeviceNet and CAN) for the axis.

The Counts-per-Force, Counts-per-Torque, and Scaling Factor for DeviceNet and CAN factors can be found on *Configurations* web page (refer to [Section 4.6—Configurations Web Page \(config.htm\)](#)).

**Table 15.3—Output Mapping**

Byte	BitNumber	Name	Description/Function
0	0	Bias	Perform tare function to zero out any load reading
	1	Reset Latch	Reset Condition latch
	2	reserved	reserved
	3	reserved	reserved
	4	reserved	reserved
	5	reserved	reserved
	6	reserved	reserved
	7	reserved	reserved
1	0	Config Select bit 0	Selects a Net F/T configuration, from 0 to 15
	1	Config Select bit 1	
	2	Config Select bit 2	
	3	Config Select bit 3	
	4	reserved	reserved
	5	reserved	reserved
	6	reserved	reserved
	7	reserved	reserved
2	0-7	Condition high	Condition enable mask, high byte
3	0-7	Condition low	Condition enable mask, low byte

Output byte 0, bit 0 performs a bias function when it is set to one. For details on this function, refer to the *Bias* button information in [Section 4.2—Snapshot Web Page \(rundata.htm\)](#). Bit 0 should be set to one for at least 100 ms to ensure the bias is executed, and then Bit 0 returns to zero.

Output byte 0, bit 1 performs a reset Condition latch function when it is set to one. For details on this function, refer to the *Reset Latch* button information in [Section 4.5—Monitor Conditions Web Page \(moncon.htm\)](#). Bit 1 should be set to one for at least 100 ms to ensure a reset latch is executed, and then Bit 1 returns to zero.

Output byte 0, bits 2–7 are reserved and should not be used.

Output byte 1, bits 0–3 select the active configuration (0 through 15) to be used. After a delay of up to one second, the newly-selected configuration is usable. During configuration change, the Net F/T does not supply valid F/T data. For details on the active configuration, refer to the active configuration information in [Section 4.4—Settings Web Page \(setting.htm\)](#).

Output byte 1, bits 4–7 are reserved and should not be used.

Output bytes 2 and 3 form a 16-bit Condition enable mask that enables and disables Condition conditions. Each bit, 0–15 (of the Condition enable mask) maps directly to its corresponding Condition condition number N. A value of one enables the corresponding condition, and a value of zero disables the condition. For more information on Monitor Conditions, refer to [Section 4.5—Monitor Conditions Web Page \(moncon.htm\)](#).

**NOTICE:** When Fieldbus Module Enabled is set to Enabled on the *Communications Settings* page (refer to [Section 4.7—Communication Settings Page \(comm.htm\)](#)), active configuration selection and Monitor Conditions statement selection is controlled by the PROFINET output data. While enabled, these values are not controlled by Net Box web pages or CGI interface.

## 15.1.2 Communications CGI (comm.cgi) Options

The PROFINET Fieldbus Net Box can have the PROFINET function enabled and disabled via CGI. The following function is available in the comm.cgi in addition to those shown in [Table 7.4](#):

Table 15.4—PROFINET Interface Parameters		
Variable Name	Allowed Values	Description
fieldbusenabled	Integers: 0 or 1	Enable (value=1) or disable (value=0) the PROFINET fieldbus interface.

## 15.1.3 XML Page Elements

The PROFINET Fieldbus Net Box has two additional XML elements included in the netftapi2.xml page output. The following elements are available in the netftapi2.xml page in addition to those shown in [Table 8.2](#):

Table 15.5—Additional netftapi2.xml XML Elements			
XML Element	Data Type	Description	Reference
fieldbusenabled	ENABL	PROFINET interface setting	comm
fieldbusfirmware	STRING64	PROFINET interface firmware version	comm

## 15.1.4 Returning Default Settings

The PROFINET Station Name and the PROFINET IP address can be cleared to default settings. This is useful when already-configured devices need to be moved or replaced in the PROFINET network. To return the PROFINET fieldbus Net Box to default PROFINET settings, the power must be on and the fieldbus module must already be enabled (see [Section 4.7—Communication Settings Page \(comm.htm\)](#)). The PROFINET network connection should be disconnected to ensure the Net Box does not automatically get recommissioned. The steps are:

1. Remove the Net Box cover (see [Section 3.9—DIP Switches and Termination Resistor](#)).
2. Move DIP switch 10 to the ON position.
3. Once the MS LED is blinking red, return DIP switch 10 to the OFF position.
4. Replace the Net Box cover.
5. Disconnect power. The PROFINET Station Name and IP address will be reset when power is reapplied.

**NOTICE:** Returning to the PROFINET default settings does not affect the standard Ethernet and EtherNet/IP settings.

## 15.1.5 Replacing and Installed PROFINET Fieldbus Net Box

Replacing an installed PROFINET Fieldbus Net Box can easily be done if (both):

- The Topology of the PROFINET network was properly defined with the PROFINET engineering tool.
- The PROFINET controller supports automatic device replacement.

### 15.1.5.1 Replacing and Installing a PROFINET Fieldbus Net Box

1. Remove the power and network connections of the PROFINET Fieldbus Net Box that is to be replaced. If necessary, mechanically unmount the Net Box.
2. Mount the replacement PROFINET Fieldbus Net Box.
3. Connect the power and PROFINET network connections to the box.
  - The new Net Box is automatically assigned the name and IP address of the former Net Box.
  - After a few seconds, the NS/BF LED turns a solid green, and the Net Box is correctly operating on the network.

### 15.1.5.2 Replacement with Previously Commissioned Fieldbus Net Box

1. Remove the power and network connections of the PROFINET Fieldbus Net Box that is to be replaced. If necessary, mechanically unmount the Net Box.
2. Mount the replacement PROFINET Fieldbus Net Box.
3. Connect the power to the box. Do not make the network connection.
4. Remove the previous commission per the steps in [Section 15.1.4—Returning Default Settings](#).
5. Connect the PROFINET Fieldbus Net Box to the PROFINET network.
  - The new Net Box is automatically assigned the name and IP address of the former Net Box.
  - After a few seconds, the NS/BF LED turns a solid green, and the Net Box is correctly operating on the network.

## 16. Advanced Topics

### 16.1 Improving Ethernet Throughput

In an optimum network setup, the Net F/T's RDT data arrives at the host computer with no loss of data. If data samples are lost, consider one or all of the following:

#### 16.1.1 Establish a Direct Connection between Net F/T and Host

To achieve the best Ethernet performance without lost data packages, connect the Net Box directly to the host computer (recommended). To use a switch, try to use only one switch between the sensor system and host. Avoid going through several switches or going through a hub.

#### 16.1.2 Choose the Best Operating System for the Application

The Windows operating system periodically performs housekeeping processes that can require a significant amount of processing power over a short amount of time. During these intervals, a loss of data can occur because Windows does not treat UDP data with a high enough priority. If this instance is not acceptable for an application, then use a real-time operating system.

#### 16.1.3 Increase Operating System Performance

For optimal computer performance in response to the Net F/T's fast data rates, consider the following:

**Disable software firewall.** One way to improve the Ethernet performance is not to have any software firewall activated. In some cases, IT personnel may need to assist.

**Disable file and printer sharing.** The processes associated with file and printer sharing can slow down an operating system's response to Ethernet data and may lead to lost data.

**Disable unnecessary network services.** Unnecessary network services and protocols can slow down an operating system's response to Ethernet data and may lead to lost data. For the best UDP performance, try to turn off every network service except for TCP/IP.

**Use an Ethernet traffic snooter.** An Ethernet traffic snooter can be invaluable in detecting unforeseen processes using-up Ethernet bandwidth and potentially slowing down the response of the computer's operating system. A traffic snooter is an advanced technique that a user's IT department may need to set-up. The free software program Wireshark ([www.wireshark.org](http://www.wireshark.org)) is commonly used as a traffic snooter.

**Use a dedicated computer.** A dedicated measurement computer that is isolated from the company network and not burdened by the company network processes.

#### 16.1.4 Avoid Connecting the Net F/T to the Organization's Network

Being connected to a network requires the periodic access to the Ethernet interface by processes other than the measurement application. This type of network connection can lead to loss of Net F/T UDP data.

#### 16.1.5 Use a Dedicated Ethernet Network for the Net F/T

Placing the Net F/T on a dedicated Ethernet network with no other devices on the network, other than the host computer, removes data collisions and gives the best network performance.

## 16.2 Reducing Noise

### 16.2.1 Mechanical Vibration

In many cases, perceived noise is actually a real fluctuation of force and/or torque, caused by vibrations in the tooling or the robot arm. The Net F/T system offers digital low-pass filters that can dampen frequencies above a certain Condition. If this is not sufficient, add a digital filter to the application software.

### 16.2.2 Electrical Interference

If observing interference by motors or other noise-generating equipment, check the Net F/T's ground connections.

If sufficient grounding is not possible or does not reduce the noise, consider using the Net F/T's digital low pass filters.

Verify the use of Class 1 power supply which has an earth ground connection.

## 16.3 Detecting Failures (Diagnostics)

### 16.3.1 Detecting Sensitivity Changes

Sensitivity checking of the transducer can also be used to measure the transducer system's health. Apply known loads to the transducer and verifying the system output matches the known loads, for example: a transducer mounted to a robot arm may have an end-effector attached to it. If the end-effector has moving parts, they must be moved in a known position.

This check is done by completing the following steps:

1. Place the robot arm in an orientation that allows the gravity load from the end-effector to exert load on many transducer output axes.
2. Record the output readings.
3. Position the robot arm to apply another load (this time causing the outputs to move far from the earlier readings).
4. Record the second set of output readings.
5. Find the differences from the first and second set of readings, and use it as the sensitivity value.

Even if the values vary somewhat from sample set to sample set, they can be used to detect gross errors. Either the resolved outputs or the raw transducer voltages may be used (the same must be used for all steps of this process).

## 16.4 Scheduled Maintenance

### 16.4.1 Periodic Inspection

For most applications, there are no parts that need to be replaced during normal operation. With industrial-type applications that continuously or frequently move the system's cabling, periodically check the cable jacket for signs of wear. These applications should implement the procedures discussed in [Section 16.3—Detecting Failures \(Diagnostics\)](#) to detect any failures.

The transducer must be kept free of excessive dust, debris, or moisture. Applications with metallic debris (i.e., electrically-conductive) must protect the transducer from this debris. Transducers without specific factory-installed protection are to be considered unprotected. The internal structure of the transducers can become clogged with particles and will become uncalibrated or even damaged.



## 16.5 A Word about Resolution

ATI's transducers have a three sensing beam configuration where the three beams are equally spaced around a central hub and attached to the outside wall of the transducer. This design transfers applied loads to multiple sensing beams and allows the transducer to increase its sensing range in a given axis if a counterpart axis has reduced (see *9620-05-Transducer Section* manual).

The resolution of each transducer axis depends on how the applied load is spread among the sensing beams. The best resolution occurs in the scenario when the quantization of the gages is evenly distributed as load is applied. In the worst case scenario, the discrete value of all involved gages increases at the same time. The typical scenario will be somewhere between these two.

F/T resolutions are specified as typical resolution, defined as the average of the worst and best case scenarios. Because both multi-gage effects can be modeled as a normal distribution, this value represents the most commonly perceived, average resolution. Although this misrepresents the actual performance of the transducers, it results in a close (and always conservative) estimate.

## 16.6 Connecting to Specific Industrial Robots

Many industrial robots connect to the Net F/T over its EtherNet/IP connection. When connecting to the Net F/T using EtherNet/IP, the Net F/T's EtherNet/IP protocol must be enabled and its DeviceNet protocol must be disabled (by enabling CAN bus protocol). This can be done on the Net F/T's *Communications* page (refer to *Section 4.7—Communication Settings Page (comm.htm)*).

**Figure 16.1—Enabling EtherNet/IP on the Communications Page (comm.htm)**

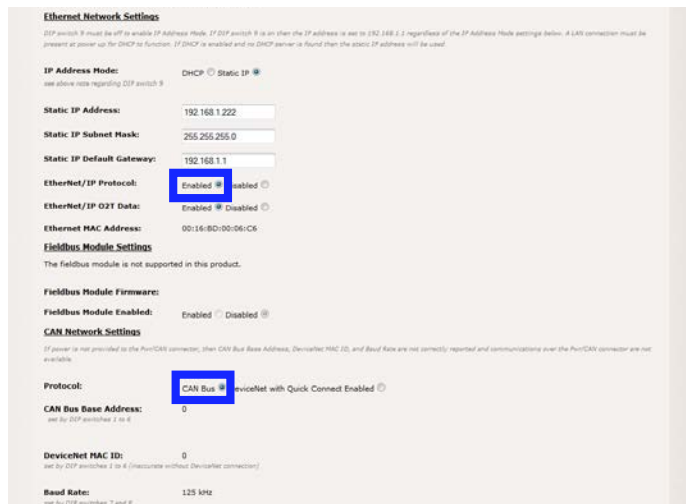

To configure the connection to the Net F/T, refer to the following information:

Item	Decimal Value	Hexadecimal Value
Vendor Code	555	0x022B
Product Type	0	0x0
Product Code	1	0x1
Major Revision	1	0x1
Minor Revision	20	0x14
Configuration Instance	128	0x80
Target to Originator (input) Instance	100	0x64
Originator to Target (output) Instance	102	0x66
Input Size (bytes)	28	0x1C
Output Size (byte) I/O Output is unused	0	0x0

### 16.6.1 ABB Robotics

ABB robot controller firmware versions 5.14 and later support EtherNet/IP connections to the Net F/T.

### 16.6.2 Denso Robotics

Denso RC7 robot controllers with EtherNet/IP support connections to the Net F/T.

### 16.6.3 Fanuc Robotics

Fanuc robot controllers with an EtherNet/IP scanner installed can communicate with the Net F/T. Details about the Fanuc EtherNet/IP scanner can be found in the Fanuc manual FANUC Robotics SYSTEM R-30iA EtherNet/IP Setup and Operations Manual MAROCENTET04081E REV B Version 7.40.

Fanuc R30iA robot controller configuration. See Section 4.2.4—Advanced EtherNet/IP Scanner Configuration in the Fanuc manual for additional information:

- Set the robot as the EtherNet/IP scanner (Client).
- In the robot controller’s scan list, set the Connection Type for the Net F/T to Input-Only.
- For TCP communications, set the Transport Type to UNICAST in order to use the Socket Messaging. For UDP communications, set the robot controller’s Transport Type to MULTICAST.
- If the controller’s word size is set to 16-BIT WORDS, then set the input size to 14 or for 8-BIT BYTES, then set the input size to 28. Pages 4–7 and 4–8 of the Fanuc manual discuss input and output sizes and how to set 8-bit or 16-bit words.
- The Output Run/Idle header must be turned off (set to Heartbeat).

**Figure 16.2—Example Configuration Settings**

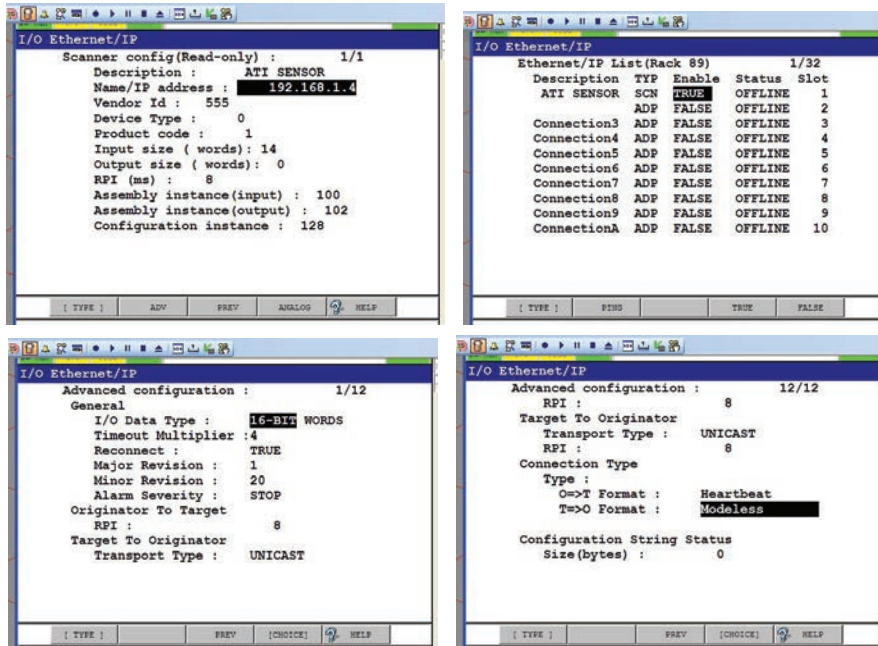

Some Karel programming is because the Fanuc robot controller does not support the following types of data:

- DINT (Double Integer)
- EtherNet/IP data of 32 bits. Two words of 16 bits (high and low) will need to be combined to use 32 bits.
- Two’s complement.

### **16.6.4 Kuka Robotics**

Kuka robots with the KUKA.ForceTorqueControl package connect to the Net F/T and provide the robot with real-time force control.

### **16.6.5 Motoman Robotics**

A Motoman robot controller with an EtherNet/IP add-on board is required for connections to the Net F/T.

## 17. Troubleshooting

This section includes answers to some issues that might arise when setting up and using the Net F/T system. The question or problem is listed followed by its probable answer or solution. They are categorized for easy reference.

The information in this section should answer many questions that might arise in the field. Customer service is available to users who have problems or questions addressed in the manuals.

Note:

Please read the manual before calling customer service. Before calling, have the following information available:

1. Serial number (e.g., FT01234)
2. Transducer model (e.g., Nano17, Gamma, Theta, etc.)
3. Calibration (e.g., US-15-50, SI-65-6, etc.)
4. Accurate and complete Description of the question or problem
5. Computer and software information (operating system, PC type, drivers, application software, and other relevant information about the configuration).

If possible, be near the F/T system when calling.

For assistance, please refer to one of the following contacts:

**ATI Industrial Automation (a Novanta Company)**

1031 Goodworth Drive  
Apex, NC 27539 USA  
[www.ati-ia.com](http://www.ati-ia.com)  
Tel: +1 919-772-0115  
Fax: +1 919-772-8259

**Application Engineering**

E-mail: [ft.support@novanta.com](mailto:ft.support@novanta.com)

24/7 Support: +1 855 ATI-IA 00 (+1 855-284-4200)

### 17.1 System Status Code

Answers to some issues that might arise when setting up and using the Net F/T system are discussed in the following section. The question or problem is listed followed by its probable answer or solution. They are categorized for reference.

The Net F/T performs many diagnostic checks during operation and reports results in a 32-bit system status code. Each F/T record includes this system status code. The bit patterns for all present error conditions are or'ed together to form the system status code. If any error condition is present then bit 31 of the system status code is set.

Bit 16 is set if a Condition is latched. This bit does not indicate a system error.

The system status code should be:

0x00000000 if no errors and no Condition statements are breached

0x80010000 if no errors and a Condition statement is breached.

Any other code signals means there is a serious error. Possible errors and their bit assignments are in [Table 17.1](#).

**Table 17.1—System Status Code Bit Assignments**

Bit	Bit Pattern	Description
31	0x80000000	Error bit (set if any error condition exists)
30	0x40000000	CPU or RAM error
29	0x20000000	Digital board error
28	0x10000000	Analog board error
27	0x08000000	Serial link communication error
26	0x04000000	Program memory verification error
25	0x02000000	Halted due to configuration errors
24	0x01000000	Settings validation error
23	0x00800000	Configuration settings incompatible with transducer calibration
22	0x00400000	Network communication failure
21	0x00200000	CAN communication error
20	0x00100000	RDT communication error
19	0x00080000	EtherNet/IP protocol failure
18	0x00040000	DeviceNet-compatibility mode protocol failure
17	0x00020000	Transducer Saturation or A/D operation error
16	0x00010000	Monitor Condition Latched
15	0x00008000	reserved
14	0x00004000	Watchdog timeout error
13	0x00002000	Stack check error
12	0x00001000	Serial EEPROM I2C communications failure
11	0x00000800	Serial flash SPI communications failure
10	0x00000400	Analog board watchdog timeout error
9	0x00000200	Excessive strain gage excitation current
8	0x00000100	Insufficient strain gage excitation current
7	0x00000080	Artificial analog ground out of range
6	0x00000040	Analog Board power supply too high
5	0x00000020	Analog Board power supply too low
4	0x00000010	Serial link data unavailable
3	0x00000008	Reference voltage or power monitoring error
2	0x00000004	Internal temperature error
1	0x00000002	HTTP protocol failure
0	0x00000001	reserved
–	0x00000000	Healthy

## 17.2 Status Word

The Status Word is a bitmap which contains information about the errors that can occur in various subsystems of the Digital F/T sensor.

Table 17.2—Status Word Bit Assignments	
Bit	Description
0	Watchdog reset – the analog board was reset by the watchdog timer.
1	Excitation voltage too high
2	Excitation voltage too low
3	Artificial analog ground out of range (above 0.007V).
4	Power supply too high ( > 25V).
5	Power supply too low ( < 10 V).
6	Not used.
7	Error accessing stored settings in EEPROM – EEPROM hardware did not respond.
8	Invalid configuration data (baud rate).
9	Strain gauge bridge supply current too high ( > 3V on current sense).
10	Not used (was Strain gauge bridge supply current too low)
11	Thermistor too high (> 100C (1.5V on thermistor) ).
12	Thermistor too low. (< -40C (0.1V on thermistor) ).
13	Not used (was DAC reading out of range )
14	Not used.
15	Any error sets this bit.

### 17.3 Questions and Answers

Table 17.3—Powering Up	
Question/Problem	Answer/Solution
Xdcr LED stays red after the twenty second power up phase	Check transducer cable connections. Verify transducer cable is not damaged. There may be an internal error in the Net Box.
Xdcr LED is red for the first twenty seconds after power up then turns green	This is normal operation.
The LS EN (Ethernet Link Status) is not green or flashing green	Check Ethernet cable connections.

Table 17.4—Communications	
Question/Problem	Answer/Solution
What IP address is assigned to the Net F/T?	See <a href="#">Section 6.1—Finding Net F/Ts on the Network</a> .
How can the Net F/T system be set to the default IP address of 192.168.1.1	Set DIP switch 9 to the ON position (see <a href="#">Section 3.9—DIP Switches and Termination Resistor</a> ). The Net F/T must be power cycled for the new setting to be used.
DHCP is not assigning an IP address	Ethernet LAN must be connected during power up. DHCP is not selected as the IP Address Mode on the <i>Communications</i> web page (refer to <a href="#">Section 4.7—Communication Settings Page (comm.htm)</a> ). The DHCP server waits more than thirty seconds to respond.
Browser cannot find the Net F/T on Ethernet network even though the Net F/T configuration utility reports an IP address	Clear the Windows computer's ARP table to remove memory of a previous device that used the same IP address as the Net F/T by restarting the computer or, with administrative privileges, by going to the computer's Start menu, selecting Run..., and typing "arp -d *".
Incorrect CAN Bus Base Address, DeviceNet MAC ID, and/or Baud Rate reported	Power must be present on the Pwr/CAN connector to correctly report these values.
System status reports DeviceNet Protocol Failure when using DeviceNet	DeviceNet is not available unless power is present on the Pwr/CAN connector.

Table 17.5—Java Demo	
Question/Problem	Answer/Solution
Demo displays zeros for force and torque values and question marks for configuration data	Check IP address and restart demo.
Excessive IO exception: Receive timed out errors	The Ethernet connection was interrupted. Check Ethernet cabling and Net F/T power.
Error message: IO exception: <path and file name> (The process cannot access the file because it is being used by another process)	Selected file for data is in use by another program. Close file or change file name and press Collect Streaming again.
The message Could not find the main class. Program will exit appears in a window titled Java Virtual Machine Launcher.	Computer requires a newer version of Java. Java may be downloaded from <a href="http://www.java.com/getjava">www.java.com/getjava</a> .



Table 17.6—Web Pages	
Question/Problem	Answer/Solution
The Invalid Request page appears	One or more entries on the previous web page were invalid or out of range. Go back to the previous page and review the last entry. Make only one change at a time to make debugging easier.
The HTTP 1.0 401 Error - Unauthorized page appears	An unsuccessful attempt to access a protected page of the web server. These pages are reserved for ATI Industrial Automation maintenance.

### 17.3.1 Errors with Force and Torque Readings

Invalid data from the transducer’s strain gages can cause errors in force/torque readings. These errors can result in problems with Condition monitoring, transducer biasing, and accuracy. Basic conditions of invalid data are listed in the following table. Use this following table to troubleshoot a problem. In most cases, problems can be better identified while looking at the raw strain gage data, displayed on the *Snapshot* web page. See [Section 4.2—Snapshot Web Page \(rundata.htm\)](#) for more details.

Table 17.7—Errors with Force and Torque Readings	
Question/Problem	Answer/Solution
Sat LED glows red (transducer saturation)	Saturation occurs if the transducer is loaded beyond its maximum measurement range or in the event of an electrical failure within the system. The error status will stay on until the saturation error stops.  When the data from a raw decimal strain gage reads the positive or negative maximums (nominally -32768 or +32767), that gage is saturated. This sets the saturation error bit in the system status code (see <a href="#">Section 17.1—System Status Code</a> ) and causes the Sat LED to turn red.
Noise	Jumps in raw strain gage readings (with transducer unloaded) greater than 80 counts is considered abnormal. Noise can be caused by mechanical vibrations and electrical disturbances, possibly from a poor ground. It can also indicate component failure within the system. See <a href="#">Section 16.2—Reducing Noise</a> .
Drift	After a load is removed or applied, the raw gage reading does not stabilize, but continues to increase or decrease. This may be observed more easily in resolved data mode using the bias command. Drift is caused by temperature change, mechanical coupling, or internal failure. Mechanical coupling is caused when a physical connection is made between the tool plate and the transducer body (i.e., filings between the tool adapter plate and the transducer body). Some mechanical coupling is common, such as hoses and wires attached to a tool.
Hysteresis	When the transducer is loaded and then unloaded, gage readings do not return quickly and completely to their original readings. Hysteresis is caused by mechanical coupling (explained in Drift section) or internal failure.

Table 17.8—Connection to Specific Equipment	
Equipment Connection	Details
Fanuc robot controllers using EtherNet/IP	Set robot controller connection type to Input Only and set the robot controller as the EtherNet/IP scanner (client). When using Socket Messaging, set the transport type to Multicast for UDP or Unicast for TCP.

## 18. General Specifications

### 18.1 Environmental

The standard F/T system is designed to be used in standard laboratory or light-manufacturing conditions. Transducers with an IP60 designation are able to withstand dusty environments. Transducers with an IP65 designation can be washed down with fresh water. Transducers with an IP68 designation can be submerged in up to 10 m of fresh water.

The Net Box is rated to IP65.

#### 18.1.1 Storage and Operating Temperatures

The Net Box can be stored and used at varying temperatures.

Table 18.1—Net Box Storage and Operating Temperatures	
Storage Temperature, °C	Operating Temperature, °C
-20 to +85	-0 to +70

**NOTICE:** These temperature ranges specify the storage and operation ranges in which the system can survive without damage. They do not take accuracy into account. See ATI Industrial Automation manual [9620-05-Transducer Section](#) for transducer environmental information.

When mated with appropriate connectors, the 9105-Net Box can be used in wet environments. The 9105-NETB Net Box can only be used in humidity up to 95% RH, non-condensing.

## 18.2 Transducer Data Filtering

Frequency response of the transducer's data acquisition hardware and various filtering options are shown in the following figure. The graph does not include the effects of any mechanical filtering which occurs in any spring and mass system.

**Figure 18.1—Data Acquisition Subsystem Frequency Response (typical)**

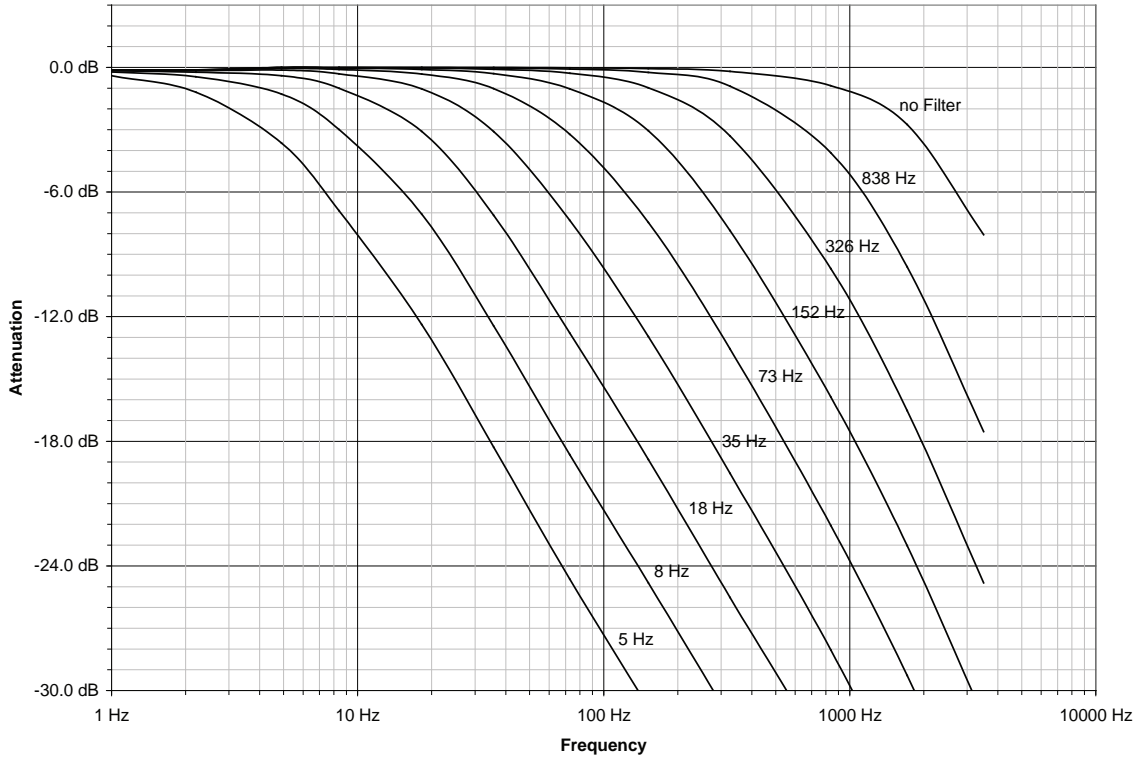

Group delays that various levels of low-pass filtering add to the signals are shown in the following figure. These delays do not show the Ethernet delays in a network or computer. With no filtering enabled, the Net F/T delivers F/T data to its Ethernet port with a delay of 286  $\mu$ S.

**Figure 18.2—Filtering Group Delays (calculated)**

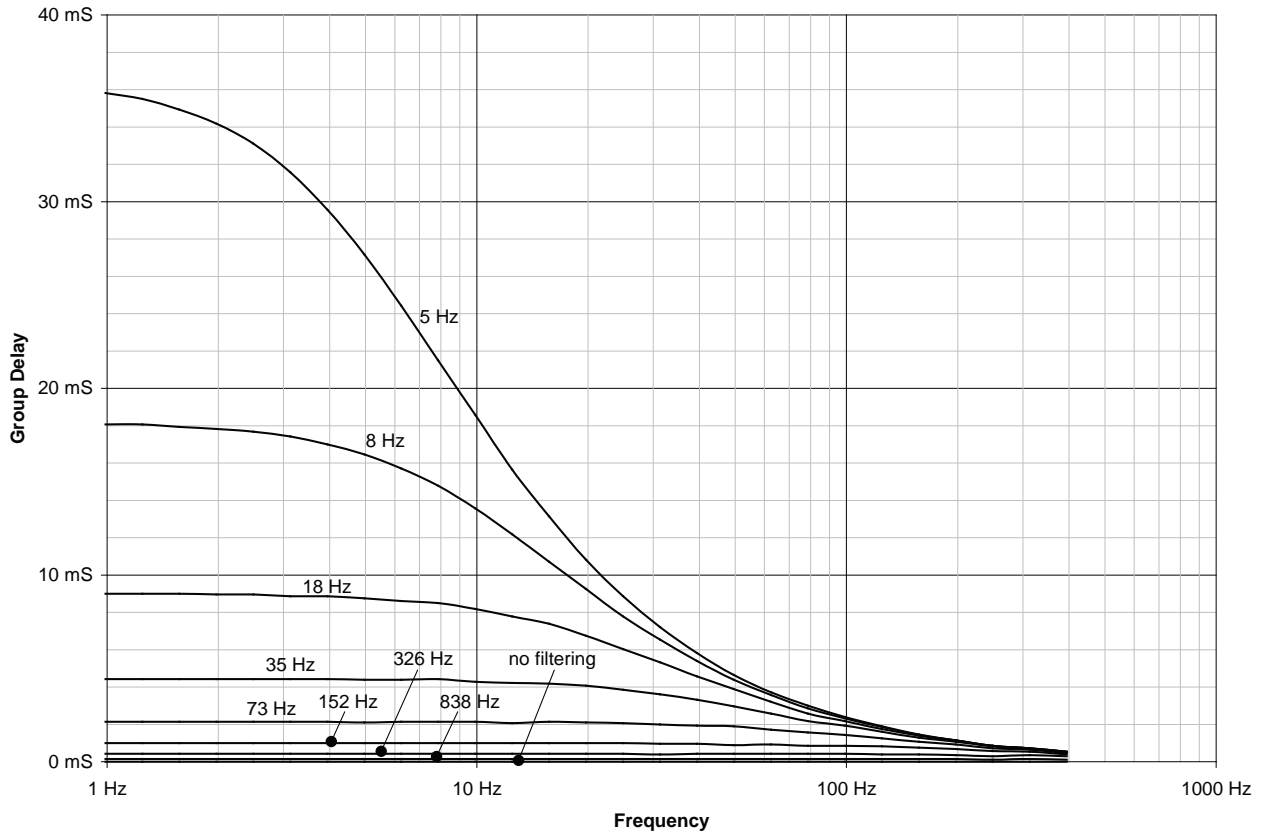

### 18.3 Electrical Specifications (Power Supply)

**Table 18.2—Power Supply Requirements**

Power Source <sup>1</sup>	Minimum Voltage	Maximum Voltage	Maximum Power Consumption
Power over Ethernet <sup>2</sup>	36 V	57 V	6 W
Pwr/CAN	11 V	25 V	6 W

Note:

1. Power is drawn from only one power source at a time.
2. Conforms to IEEE 802.3af, class 0, receiving power from data lines. Uses Mode A to receive power. Mode B is not supported.

A 9105-NET-GAMMA- transducer and its on-board electronics account for 2.4 W of the systems power consumption. Other transducer models consume less power.

#### 18.3.1 Communications

##### 18.3.1.1 Ethernet Interface

The Ethernet interface is 10/100 Mbit and features both negotiation and auto crossover. It can support up to four TCP connections and one UDP connection.

The EtherNet/IP interface supports one input-only connection and does not support a listen-only connection. It does not support any Client functionality.

### 18.3.1.2 CAN Interface

The CAN interface supports 125 kbps, 250 kbps, and 500 kbps (see [Section 3.9.3—Baud Rate](#)). A switchable termination resistor is available; refer to [Section 3.9.1—Termination Resistor](#).

### 18.3.2 Mating Connectors

Table 18.3—Mechanical Specifications of Mating Connectors			
Connector	Mating Type	Recommended Torque	Maximum Torque
Ethernet	M12 D-Coded, 4-Pin, male	0.8 Nm to 1.0 Nm	3.0 Nm
Condition Relay	M8 3-Pin, female	0.5 Nm to 0.6 Nm	1.0 Nm
Pwr/CAN	M12 5-Pin, female	0.8 Nm to 1.0 Nm	3.0 Nm
NETB Transducer	M12 5-Pin, male	0.8 Nm to 1.0 Nm	3.0 Nm
NETBA Transducer	Circular, female	0.7 Nm	

### 18.3.3 Standard Condition Relay

The standard Condition relay contacts (NC, NO, or COM) are protected against overload by a resettable fuse. The relay will turn on within 6 ms.

Table 18.4—Standard Condition Relay Specifications		
	Maximum Rating	Maximum Load
Current	50 mA	10 $\mu$ A
Voltage	42VDC, 30VAC	10 mVDC

### 18.3.4 Solid-State Condition Relay

The optional solid state Condition relay contacts (SSR+ and SSR-) are protected against reverse voltage by a zener diode. The relay turns on within 500  $\mu$ s.

Table 18.5—Solid-State Relay Specifications	
	Maximum Load
Current	35 mA
Voltage	30VDC

Figure 18.3—Solid-State Relay Voltage Drop vs. Current

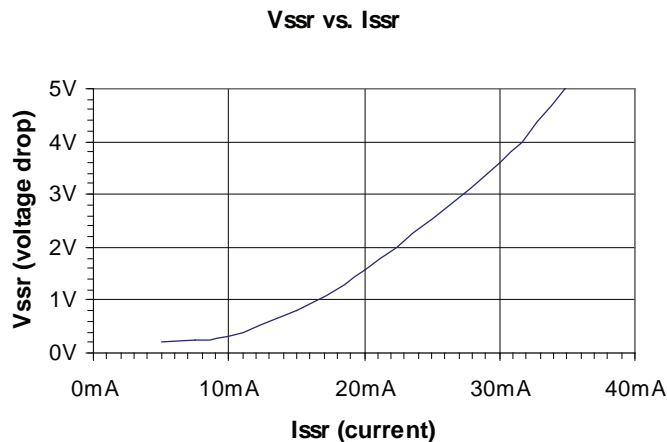

### 18.3.5 NetBox Transducer Cabling

Normally the NetBox connects to the Transducer via an industry-standard DeviceNet cordset. In cases where this type of cordset cannot be used, observe the following:

- Cable specifications for DeviceNet Thick Cabling are ideal.
- The RS485+ and RS485- lines must form a twisted pair.
- The cable capacities should be low enough to work with 1.25 Mbps.
- The total resistance of each conductor should be no more than 0.5  $\Omega$

**Figure 18.4—Netbox’s Transducer Cable Connector (female Pins)**

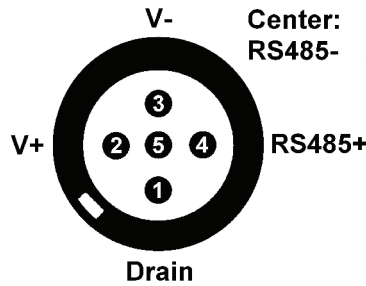

**Figure 18.5—Transducer’s Transducer Cable Connector (male pins)**

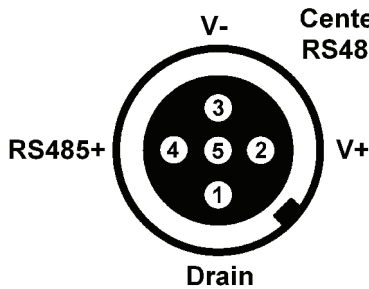

### 18.4 Net Box Weight

**Table 18.6—Net Box Weight**

Condition	Weight
Without Mounting Plate	0.8 kg (1.8 lbs)
With Mounting Plate	1.1 kg (2.4 lbs)